

Dell™ OptiPlex™ 210L User's Guide



[Mini-Tower Computer](#)



[Desktop Computer](#)

[Back to Contents Page](#)

Advanced Features

Dell™ OptiPlex™ 210L User's Guide

- [LegacySelect Technology Control](#)
 - [Manageability](#)
 - [Security](#)
 - [Password Protection](#)
 - [System Setup](#)
 - [Booting to a USB Device](#)
 - [Clearing Forgotten Passwords](#)
 - [Clearing CMOS Settings](#)
 - [Hyper-Threading](#)
 - [Power Management](#)
-

LegacySelect Technology Control

LegacySelect technology control offers legacy-full, legacy-reduced, or legacy-free solutions based on common platforms, hard-drive images, and help desk procedures. Control is provided to the administrator through system setup, Dell OpenManage™ IT Assistant, or Dell custom factory integration.

LegacySelect allows administrators to electronically activate or deactivate connectors and media devices that include serial and USB connectors, a parallel connector, a floppy drive, PCI slots, and a PS/2 mouse. Connectors and media devices that are deactivated make resources available. You must restart the computer to effect the changes.

Manageability

Dell OpenManage™ IT Assistant

IT Assistant configures, manages, and monitors computers and other devices on a corporate network. IT Assistant manages assets, configurations, events (alerts), and security for computers equipped with industry-standard management software. It supports instrumentation that conforms to SNMP, DMI, and CIM industry standards.

Dell OpenManage Client Instrumentation, which is based on DMI and CIM, is available for your computer. For information on IT Assistant, see the *Dell OpenManage IT Assistant User's Guide* available on the Dell Support website at support.dell.com.

Dell OpenManage Client Instrumentation

Dell OpenManage Client Instrumentation is software that enables remote management programs such as IT Assistant to do the following:

- 1 Access information about your computer, such as how many processors it has and what operating system it is running.
- 1 Monitor the status of your computer, such as listening for thermal alerts from temperature probes or hard-drive failure alerts from storage devices.
- 1 Change the state of your computer, such as updating its BIOS or shutting it down remotely.

A managed system is one that has Dell OpenManage Client Instrumentation set up on a network that uses IT Assistant. For information about Dell OpenManage Client Instrumentation, see the *Dell OpenManage Client Instrumentation User's Guide* available on the Dell Support website at support.dell.com.

Security

Padlock Ring and Security Cable Slot

Use one of the following methods to secure your computer:

- 1 Use a padlock alone or a padlock and looped security cable with the padlock ring.
 - A padlock alone prevents the computer from being opened.
 - A security cable looped around a stationary object is used in conjunction with a padlock to prevent unauthorized movement of the computer.
- 1 Attach a commercially available antitheft device to the security cable slot on the back of the computer.

 **NOTE:** Before you purchase an antitheft device, make sure that it works with the security cable slot on your computer.

Antitheft devices usually include a segment of metal-stranded cable with an attached locking device and key. The documentation that comes with the device contains instructions for installing it.

Password Protection

 **NOTICE:** Although passwords provide security for the data on your computer, they are not foolproof. If your data requires more security, it is your responsibility to obtain and use additional forms of protection, such as data encryption programs.

System Password

 **NOTICE:** If you leave your computer running and unattended without having a system password assigned, or if you leave your computer unlocked so that someone can disable the password by changing a jumper setting, anyone can access the data stored on your hard drive.

Option Settings

You cannot change or enter a new system password if either of the following two options is displayed:

1. **Set** — A system password is assigned.
1. **Disabled** — The system password is disabled by a jumper setting on the system board.

You can only assign a system password when the following option is displayed:

1. **Not Set** — No system password is assigned and the password jumper on the system board is in the enabled position (the default setting).

Assigning a System Password

To escape from the field without assigning a system password, press <Tab> or the <Shift><Tab> key combination to move to another field, or press <Esc> at any time before you complete step 5.

1. [Enter system setup](#) and verify that **Password Status** is set to **Unlocked**.
2. Highlight **System Password**, and then press the left- or right-arrow key.

The option heading changes to **Enter Password**, followed by an empty 32-character field in square brackets.

3. Type your new system password.

You can use up to 32 characters. To erase a character when entering your password, press <Backspace> or the left-arrow key. The password is not case sensitive.

Certain key combinations are not valid. If you enter one of these combinations, the speaker emits a beep.

As you press each character key (or the spacebar for a blank space), a placeholder appears in the field.

4. Press <Enter>.

If the new system password is less than 32 characters, the whole field fills with placeholders. Then the option heading changes to **Verify Password**, followed by another empty 32-character field in square brackets.

5. To confirm your password, type it a second time and press <Enter>.

The password setting changes to **Set**.

6. Exit system setup.

Password protection takes effect when you restart the computer.

Typing Your System Password

When you start or restart your computer, one of the following prompts appears on the screen.

If **Password Status** is set to **Unlocked**:

```
Type in the password and
- press <ENTER> to leave password security enabled.
- press <CTRL><ENTER> to disable password security.
Enter password:
```

If **Password Status** is set to **Locked**:

```
Type the password and press <Enter>.
```

If you have assigned an administrator password, the computer accepts your administrator password as an alternate system password.

If you type a wrong or incomplete system password, the following message appears on the screen:

```
** Incorrect password. **
```

If you again type an incorrect or incomplete system password, the same message appears on the screen. The third and subsequent times you type an incorrect or incomplete system password, the computer displays the following message:

```
** Incorrect password. **  
Number of unsuccessful password attempts: 3  
System halted! Must power down.
```

Even after your computer is turned off and on, the previous message is displayed each time you type an incorrect or incomplete system password.

 **NOTE:** You can use **Password Status** in conjunction with **System Password** and **Admin Password** to further protect your computer from unauthorized changes.

Deleting or Changing an Existing System Password

1. [Enter system setup](#) and verify that **Password Status** is set to **Unlocked**.
2. Restart your computer.
3. When prompted, type the system password.
4. Press <Ctrl><Enter> to disable the existing system password.
5. Confirm that **Not Set** is displayed for the **System Password** option.

If **Not Set** is displayed, the system password is deleted. If **Not Set** is not displayed, press <Alt> to restart the computer, and then repeat [step 3](#) through [step 5](#).

To assign a new password, follow the procedure in "[Assigning a System Password](#)."

6. Exit system setup.

Administrator Password

Option Settings

You cannot change or enter a new administrator password if either of the following two options is displayed:

- 1 **Set** — An administrator password is assigned.
- 1 **Disabled** — The administrator password is disabled by a Jumper setting on the system board.

You can only assign an administrator password when the following option is displayed:

- 1 **Not Set** — No administrator password is assigned and the password Jumper on the system board is in the enabled position (the default setting).

Assigning an Administrator Password

The administrator **password** can be the same as the system password.

 **NOTE:** If the two passwords are different, the administrator password can be used as an alternate system password. However, the system password cannot be used in place of the administrator password.

1. [Enter system setup](#) and verify that **Admin Password** is set to **Not Set**.
2. Highlight **Admin Password** and press the left- or right-arrow key.

The computer prompts you to type and verify the password. If a character is not permitted, the computer emits a beep.

3. Type and then verify the password.

After you verify the password, the **Admin Password** setting changes to **Set**. The next time you [enter system setup](#), the computer prompts you for the administrator password.

4. Exit system setup.

A change to **Admin Password** becomes effective immediately (no need to restart the computer).

Operating Your Computer With an Administrator Password Enabled

When you [enter system setup](#), the **Admin Password** option is highlighted, prompting you to type the password.

If you do not type the correct password, the computer lets you view, but not modify, system setup options.

 **NOTE:** You can use **Password Status** in conjunction with **Admin Password** to protect the system password from unauthorized changes.

Deleting or Changing an Existing Administrator Password

To change an existing administrator password, you must know the administrator password.

1. [Enter system setup](#).
2. Type the administrator password at the prompt.
3. Highlight **Admin Password** and press the left- or right-arrow key to delete the existing administrator password.

The setting changes to **Not Set**.

To assign a new administrator password, perform the steps in "[Assigning an Administrator Password](#)."

4. Exit system setup.

Disabling a Forgotten Password and Setting a New Password

To reset system and/or administrator passwords, see "[Clearing Forgotten Passwords](#)."

System Setup

Overview

Use system setup as follows:

1. To change the system configuration information after you add, change, or remove any hardware in your computer
1. To set or change a user-selectable option such as the user password
1. To read the current amount of memory or set the type of hard drive installed

Before you use system setup, it is recommended that you write down the system setup screen information for future reference.

Entering System Setup

1. Turn on (or restart) your computer.
2. When the blue DELL™ logo appears, press <F2> immediately.

If you wait too long and the operating system logo appears, continue to wait until you see the Microsoft® Windows® desktop. Then [shut down your computer](#) and try again.

System Setup Screens

The system setup screen displays current or changeable configuration information for your computer. Information on the screen is divided into three areas: the options list, active options field, and key functions.

Options List — This field appears on the left side of the system setup window. The field is a scrollable list containing features that define the configuration of your computer, including installed hardware, power conservation, and security features.

Scroll up and down the list by using the up and down arrow keys. As an option is highlighted, the **Option Field** displays more information about that option and the option's current and available settings.

Option Field — This field contains information about each option. In this field you can view your current settings and make changes to your settings.

Use the right- and left-arrow keys to highlight an option. Press <Enter> to make that selection active.

	<p>Key Functions — This field appears below the Option Field and lists keys and their functions within the active system setup field.</p>

System Setup Options

 **NOTE:** Depending on your computer and installed devices, the items listed in this section may or may not appear.

System	
System Info	Lists the computer name, BIOS version, and service tag.
CPU Info	Identifies whether the computer's processor supports Hyper-Threading and identifies the CPU speed, bus speed, clock speed, and L2 cache.
Memory Info	Indicates amount of installed memory, computer memory speed, amount of video memory, size of the display cache, and channel mode (dual or single).
Date/Time	Displays current date and time settings.
Boot Sequence	The computer attempts to boot from the sequence of devices specified in this list.
Drives	
Diskette Drive	This option enables or disables the floppy drive. The options are Off , Internal , USB , and Read Only .
Drive 0 through Drive n	Identifies and enables and disables the drives attached to the SATA or IDE connectors on the system board and lists the capacities for the hard drives. NOTE: These options appear as Drive 0 through Drive 3 .
Module Bay	Enables or disables devices in the module bay. The options are On or Off . The default setting is On . NOTE: The USB Controller and Diskette Drive setup option affect operation of the optional floppy drive in the module bay.
Drive Controller	Configures the serial ATA controller's operating mode. Normal enables the serial ATA controller to operate in its serial ATA native mode only. Compatible enables the serial ATA controller to operate in serial/parallel ATA combination mode.
Error Reporting	This setting determines whether hard drive errors are reported or not during system setup.
SATA Operation	Configures the operation mode of the integrated hard-drive controller. Normal — The hard-drive controller is configured for native mode. This mode provides the highest drive performance and most flexibility. Combination — The hard-drive controller is configured for combination mode. This mode enables compatibility with some older operating systems that do not support SATA drives. The factory default setting is Normal . NOTE: Changing this setting affects the order in which drives are listed. However, system setup does not reflect these changes until after a reboot.
SATA Reporting	Controls whether hard drive errors for integrated drives are reported during system status. This technology is part of the SMART (Self-Monitoring Analysis and Reporting Technology) specification. The options are On or Off . The default setting is Off .
Onboard Devices	
Integrated NIC	You can set the NIC to On (default setting), Off , or On w/ PXE . When the On w/ PXE setting is active (available only for the future boot process), the computer prompts the user to press <Ctrl><Alt>. Pressing this key combination causes a menu to display that allows you to select a method for booting from a network server. If a boot routine is not available from the network server, the system attempts to boot from the next device in the boot sequence list.
Integrated Audio	Enables or disables the onboard audio controller
LPT Port Mode	This option sets the operating mode for the built-in parallel port. The settings are Off , AT , PS/2 (default setting), EPP , and ECP .

	<ul style="list-style-type: none"> 1 AT — The port is configured for IBM® AT compatibility. 1 PS/2 — The port is configured for IBM PS/2 compatibility. 1 EPP — The port is set for enhanced parallel port protocol. 1 ECP — The port is set for extended capability port protocol.
LPT Port Address	This option sets the address that the built-in parallel port uses. The settings are 378h (default setting), 278h , and 3BCh .
PCI Slots	Enables or disables the PCI slots.
Serial Port #1	Auto , the default setting, automatically configures a connector to a particular designation (COM1 or COM3).
USB	USB devices are detected and supported in the operating system when this option is set to On .
USB Disable	Enables or disables the front-panel USB connectors. The default setting is On . To disable the front-panel connectors, select Off .
USB Controller	<p>Enables and disables the integrated USB controller</p> <p>Off — The USB controller is disabled</p> <p>On — The USB controller is enabled</p> <p>No Boot — The USB controller is enabled; however, the BIOS will not recognize USB storage devices.</p> <p>The factory default setting is On.</p>
Front USB Ports	<p>Enables and disables the front-panel USB ports.</p> <p>Off — Disabled</p> <p>On — Enabled</p> <p>The factory default setting is On.</p>
LPT Port Mode	<p>Selects the mode of operation for the integrated parallel port.</p> <p>Off — Port is disabled</p> <p>AT — Port is configured for IBM AT compatibility</p> <p>PS/2 — Port is configured for IBM PS/2 compatibility</p> <p>EPP — Enhanced parallel port protocol</p> <p>ECP — Extended Capability port protocol</p> <p>The factory default setting is PS/2.</p>
LPT Port Address	Selects the base IO address for the integrated parallel port. The factory default setting is 378h .
Video	
Primary Video	This setting specifies which video controller is primary when two video controllers are present on the computer.
Video Memory Size	This setting specifies the amount of memory available to video controllers.
Performance	
Hyper-Threading	If your computer's processor supports Hyper-Threading, this option appears in the Options List .
IDE Performance	<ul style="list-style-type: none"> 1 Quiet (default setting)— The hard drive operates at its most quiet setting. 1 Performance — The hard drive operates at its maximum speed. 1 Bypass — Your computer does not test or change the current acoustics mode setting. 1 Suggested — The hard drive operates at the level suggested by the drive manufacturer. <p>NOTE: Switching to performance mode may cause the drive to be noisier, but its performance is not affected. Changing the acoustics setting does not alter your hard-drive image.</p>
Security	
Admin Password	<p>This option provides restricted access to the computer's System Setup program in the same way that access to the system can be restricted with the System Password option. The settings are Set, Not Set, and Disabled.</p> <p>If the option is to Set, an administrator password is assigned.</p> <p>If the option is to Not Set, no administrator password is assigned and the password jumper on the system board is in the enabled position (the default setting).</p> <p>If the option is to Disabled, the administrator password is disabled by a jumper setting on the system board.</p> <p>To disable the administrator password, enter the password at the prompt and hit <Ctrl><Enter>.</p>
System Password	<p>Displays the current status of the system's password security feature and allows a new system password to be assigned and verified. The settings are Set, Not Set, and Disabled.</p> <p>If the option is Set, a system password is assigned.</p> <p>If the option is Not Set, no system password is assigned and the password jumper on the system board is in the enabled position (the default setting).</p>

	<p>If the option is Disabled, the system password is disabled by a jumper setting on the system board.</p> <p>To disable the system password, enter the password at the prompt and hit <Ctrl><Enter>.</p>
Drive Password	<p>Set this password to prevent unauthorized users from accessing the hard drive.</p> <p>NOTE: The option appears for each installed hard drive that supports hard-drive passwords. If no drives support a drive password, this option will not display.</p>
ModBay Password	<p>Set this password to prevent unauthorized users from accessing a hard drive installed in the module bay.</p> <p>NOTE: The option only appears for a hard drive installed in the module bay that supports hard-drive passwords. If no hard drive is installed in the module bay, or if one is installed that does not support a hard-drive password, this option will not display.</p>
Password Changes	<p>This option locks the system password field with the administrator password. When the field is locked, the option to disable password security by pressing <Ctrl><Enter> when the computer starts is no longer available.</p>
TPM Security	<p>Controls the TPM security device.</p> <p>Off — TPM security device is Off.</p> <p>On — TPM security device is On.</p> <p>The factory default setting is Off.</p>
Power Management	
AC Recovery	<p>Determines what happens when AC power is restored to the computer.</p>
Auto Power On	<p>Sets time and days of week to automatically turn on the computer. Choices are Everyday or Weekdays. The factory default setting is Off.</p> <p>This feature does not work if you turn off your computer using a power strip or surge protector.</p>
Auto Power Time	<p>Sets the specific time to automatically turn on the computer. Time is kept in a 24-hour format (<i>hours:minutes</i>). Change the start-up time by pressing the right- or left-arrow key to increase or decrease the numbers, or type numbers in both the date and time fields.</p> <p>Use this setting in conjunction with the Auto Power On setting.</p>
Low Power Mode	<p>When Low Power Mode is selected, remote wakeup events no longer turn on from Hibernate or Off unless an additional NIC card is installed.</p> <p>NOTE: This setting affects only the integrated network controller.</p>
Remote Wake-Up	<p>This option allows the system to turn on when a Network Interface Controller or Remote Wakeup-capable modem receives a wake up signal.</p> <p>On (default setting) will follow the computer's boot sequence.</p> <p>On w/Boot to NIC will allow the computer to attempt to boot from a network prior to using the boot sequence.</p> <p>NOTE: Normally, the system can be powered up remotely from suspend mode, hibernate mode, or when powered off. When Low Power Mode (in the Power Management menu) is enabled, the system can only be turned on remotely from Suspend.</p>
Suspend Mode	<p>The options are S1, a suspend mode where the computer is running in a low-power mode, and S3, a standby mode where the power is reduced or turned off for most components; however, system memory remains active.</p>
Maintenance	
Load Defaults	<p>This setting will restore the computer's factory-installed default settings. The options are Cancel and Continue/Reset CMOS.</p>
Event Log	<p>Displays the system event log.</p>
BIOS Update	<p>Select the location of the BIOS update file. The options are Floppy Disk or Hard Drive.</p>
POST Behavior	
Fast Boot	<p>When set to On (default setting), your computer will start more quickly because it will skip certain configurations and tests.</p>
Numlock Key	<p>This option involves the rightmost bank of keys on your keyboard. When set to On (default setting), this option activates the numeric and mathematical features shown at the top of each key. When set to Off, this option activates the cursor-control functions labeled on the bottom of each key.</p>
POST Hotkeys	<p>This setting specifies whether keystroke sequences are displayed when the computer starts. The default setting is Setup & Boot Menu.</p>
Keyboard Errors	<p>This option disables or enables keyboard error reporting when the computer starts.</p>

Boot Sequence

This feature allows you to change the boot sequence for devices.

Option Settings

- 1 **Onboard or USB Floppy Drive** — The computer attempts to boot from the floppy drive. If the floppy disk in the drive is not bootable, or if no floppy disk

is in the drive, the computer generates an error message.

1. **Onboard SATA Hard Drive** — The computer attempts to boot from the primary serial ATA hard drive. If no operating system is on the drive, the computer generates an error message.
1. **Onboard IDE Hard Drive** — The computer attempts to boot from the primary IDE hard drive, if applicable. If no operating system is on the drive, the computer generates an error message.
1. **Onboard or USB CD-ROM Drive** — The computer attempts to boot from the CD drive. If no CD is in the drive, or if the CD has no operating system, the computer generates an error message.

Changing Boot Sequence for the Current Boot

You can use this feature, for example, to tell the computer to boot from the CD drive so that you can run the Dell Diagnostics on the *Drivers and Utilities* CD (Resource CD), but you want the computer to boot from the hard drive when the diagnostic tests are complete. You can also use this feature to restart your computer to a USB device such as a floppy drive, memory key, or CD drive.

 **NOTE:** If you are booting to a USB floppy drive, you must first set the floppy drive to USB in [system setup](#).

1. If you are booting to a USB device, connect the USB device to a USB connector.
2. Turn on (or restart) your computer.
3. When **F2 = Setup**, **F12 = Boot Menu** appears in the upper-right corner of the screen, press <F12>.

If you wait too long and the operating system logo appears, continue to wait until you see the Microsoft Windows desktop. Then [shut down your computer](#) and try again.

The **Boot Device Menu** appears, listing all available boot devices. Each device has a number next to it.

4. At the bottom of the menu, enter the number of the device that is to be used for the current boot only.

For example, if you are booting to a USB memory key, highlight **USB Device** and press <Enter>.

 **NOTE:** To boot to a USB device, the device must be bootable. To make sure your device is bootable, check the device documentation.

Changing Boot Sequence for Future Boots

1. [Enter system setup](#).
2. Use the arrow keys to highlight the **Boot Sequence** menu option and press <Enter> to access the pop-up menu.

 **NOTE:** Write down your current boot sequence in case you want to restore it.

3. Press the up- and down-arrow keys to move through the list of devices.
4. Press the spacebar to enable or disable a device. (Enabled devices have a checkmark.)
5. Press <Shift><Up Arrow> or <Shift><Down Arrow> to move a selected device up or down the list.

Booting to a USB Device

 **NOTE:** To boot to a USB device, the device must be bootable. To ensure that your device is bootable, check the device documentation.

Memory Key

1. Insert the memory key into a USB port and restart the computer.
2. When **F12 = Boot Menu** appears in the upper-right corner of the screen, press <F12>.

The BIOS detects the device and adds the USB device option to the boot menu.

3. From the boot menu, select the number that appears next to the USB device.

The computer boots to the USB device.

Floppy Drive

1. In system setup, set the **Diskette Drive** option to **USB**.
2. Save and exit system setup.
3. Connect the USB floppy drive, insert a bootable floppy, and re-boot the system.

Clearing Forgotten Passwords

⚠ CAUTION: Before you begin any of the procedures in this section, follow the safety instructions located in the *Product Information Guide*.

🔍 NOTICE: This process erases both the system and administrator passwords.

1. Follow the procedures in "[Before You Begin](#)."
2. Locate the 2-pin password jumper (PSWD) on the system board, and remove the jumper to clear the password.

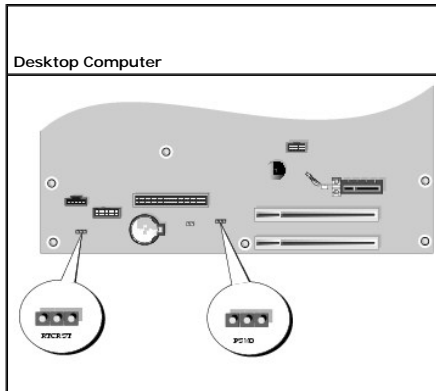
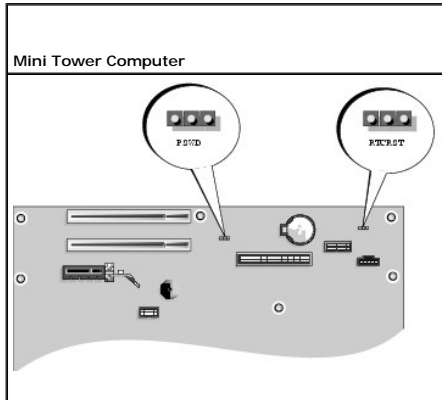

Jumper	Setting	Description
PSWD		Password features are enabled (default setting).
		Password features are disabled.
RTCRST		The real-time clock has not been reset.
		The real-time clock is being reset (jumpered temporarily).



3. [Replace the computer cover.](#)
4. Connect your computer and monitor to electrical outlets, and turn them on.
5. After the Microsoft® Windows® desktop appears on your computer, [shut down your computer.](#)
6. Turn off the monitor and disconnect it from the electrical outlet.
7. Disconnect the computer power cable from the electrical outlet, and press the power button to ground the system board.
8. Open the computer cover.
9. Locate the 2-pin password jumper on the system board and attach the jumper to reenble the password feature.
10. Replace the computer cover.

 **NOTICE:** To connect a network cable, first plug the cable into the network wall jack and then plug it into the computer.

11. Connect your computer and devices to electrical outlets, and turn them on.

 **NOTE:** This procedure enables the password feature. When you [enter system setup](#), both system and administrator password options appear as **Not Set**—meaning that the password feature is enabled but no password is assigned.

12. Assign a new system and/or administrator password.

Clearing CMOS Settings

 **CAUTION:** Before you begin any of the procedures in this section, follow the safety instructions located in the *Product Information Guide*.

1. Follow the procedures in "[Before You Begin](#)."
2. Reset the current CMOS settings:
 - a. Locate the [password \(PSWD\) and CMOS \(RTC_RST\) jumpers](#) on the system board.
 - b. Remove the password jumper plug from its pins.
 - c. Place the password jumper plug on the RTC_RST pins and wait approximately 5 seconds.
 - d. Remove the jumper plug from the RTC_RST pins and place it back on the password pins.
3. [Replace the computer cover.](#)
4. Attach the computer stand, if used.

 **NOTICE:** To connect a network cable, first plug the cable into the network wall jack and then plug it into the computer.

5. Connect your computer and devices to electrical outlets, and turn them on.

Hyper-Threading

Hyper-Threading is an Intel® technology that can enhance overall computer performance by allowing one physical processor to function as two logical processors, capable of performing certain tasks simultaneously. It is recommended that you use the Microsoft® Windows® XP Service Pack 1 (SP1) or higher operating system because Windows XP is optimized to take advantage of Hyper-Threading technology. While many programs can benefit from Hyper-Threading, some programs have not been optimized for Hyper-Threading and may require an update from the software manufacturer. Contact the software manufacturer for updates and information about using Hyper-Threading with your software.

To determine if your computer is using Hyper-Threading technology:

1. Click the **Start** button, right-click **My Computer**, and then click **Properties**.

2. Click **Hardware** and click **Device Manager**.

3. In the **Device Manager** window, click the plus (+) sign next to the processor type. If Hyper- Threading is enabled, the processor is listed twice.

You can enable or disable Hyper-Threading through [system setup](#).

Power Management

Your computer can be set to use less power when you are not working. You control the power usage through the operating system installed on your computer and certain option settings in [system setup](#). These periods of reduced power are called "sleep modes."

 **NOTE:** All components installed in the computer must support the hibernate and/or standby mode feature(s) and have the appropriate drivers loaded to enter either of these sleep modes. For more information, see the manufacturer's documentation for each component.

- 1 **Standby.** In this sleep mode, power is reduced or turned off for most components, including the cooling fans. However, system memory remains active.
- 1 **Hibernate.** This sleep mode reduces power consumption to a minimum by writing all data in system memory to a hard drive and then removing system power. Waking up from this mode restarts the computer, and the memory contents are restored. Operation then resumes where the computer left off when it entered the hibernation mode.
- 1 **Shutdown.** This sleep mode removes all power from the computer except a small auxiliary amount. As long as the computer remains connected to an electrical outlet, it can be automatically or remotely started. For example, the **Auto Power On** option in [system setup](#) allows the computer to automatically start at a specified time. Also, your network administrator can remotely start your computer using a power management event such as Remote Wake Up.

The following table lists the sleep modes and the methods you can use to wake the computer from each mode.

Sleep Mode	Wake-Up Methods (Windows XP)
Standby	<ul style="list-style-type: none">1 Press the power button1 Auto power on1 Move or click the mouse1 Type on the keyboard1 USB device activity1 Power management event
Hibernate	<ul style="list-style-type: none">1 Press the power button1 Auto power on1 Power management event
Shutdown	<ul style="list-style-type: none">1 Press the power button1 Auto power on1 Power management event

 **NOTE:** For more information on power management, see your operating system documentation.

[Back to Contents Page](#)

Battery

Dell™ OptiPlex™ 210L User's Guide

[Replacing the Battery](#)

Replacing the Battery

 **CAUTION:** Before you begin any of the procedures in this section, follow the safety instructions in the *Product Information Guide*.

 **NOTICE:** To prevent static damage to components inside your computer, discharge static electricity from your body before you touch any of your computer's electronic components. You can do so by touching an unpainted metal surface on the computer chassis.

A coin-cell battery maintains computer configuration, date, and time information. The battery can last several years.

The battery may need replacing if an incorrect time or date is displayed during the boot routine along with a message such as:

Time-of-day not set - please run SETUP program

or

Invalid configuration information -
please run SETUP program

or

Strike the F1 key to continue,
F2 to run the setup utility

To determine whether you need to replace the battery, reenter the time and date in system setup and exit the program to save the information. Turn off your computer and disconnect it from the electrical outlet for a few hours; then reconnect the computer, turn it on, and [enter system setup](#). If the date and time are not correct in system setup, replace the battery.

You can operate your computer without a battery; however, without a battery, the configuration information is erased if the computer is turned off or unplugged from the electrical outlet. In this case, you must [enter system setup](#) and reset the configuration options.

 **CAUTION:** A new battery can explode if it is incorrectly installed. Replace the battery only with the same or equivalent type recommended by the manufacturer. Discard used batteries according to the manufacturer's instructions.

To replace the battery:

1. If you have not already done so, make a copy of your configuration information, found in system setup.
2. Follow the procedures in "[Before You Begin](#)."
3. Locate the battery socket.

 **NOTICE:** If you pry the battery out of its socket with a blunt object, be careful not to touch the system board with the object. Ensure that the object is inserted between the battery and the socket before you attempt to pry out the battery. Otherwise, you may damage the system board by prying off the socket or by breaking circuit traces on the system board.

 **NOTICE:** To avoid damage to the battery connector, you must firmly support the connector while removing the battery.

4. Remove the system battery.
 - a. Support the battery connector by pressing down firmly on the positive side of the connector.
 - b. While supporting the battery connector, press the battery tab away from the positive side of the connector and pry the battery it up out of the securing tabs at the negative side of the connector.

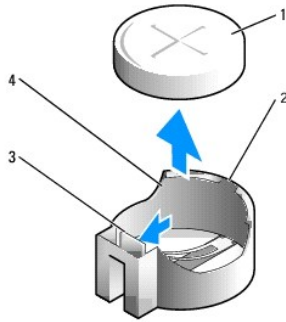

1	system battery
2	positive side of battery connector
3	battery socket tab
4	battery socket

➡ **NOTICE:** To avoid damage to the battery connector, you must firmly support the connector while replacing the battery.

5. Install the new system battery.
 - a. Support the battery connector by pressing down firmly on the positive side of the connector.
 - b. Hold the battery with the "+" facing up, and slide it under the securing tabs at the positive side of the connector.
 - c. Press the battery straight down into the connector until it snaps into place.
6. [Replace the computer cover.](#)
7. [Enter system setup](#) and restore the settings you recorded in step 1.
8. Properly dispose of the old battery as described in the *Product Information Guide*.

[Back to Contents Page](#)

Before You Begin

Dell™ OptiPlex™ 210L User's Guide

- [Recommended Tools](#)
- [Turning Off Your Computer](#)
- [Before Working Inside Your Computer](#)

This chapter provides procedures for removing and installing the components in your computer. Unless otherwise noted, each procedure assumes that the following conditions exist:

- 1 You have performed the steps in "[Turning Off Your Computer](#)" and "[Before Working Inside Your Computer](#)."
- 1 You have read the safety information in your Dell™ *Product Information Guide*.
- 1 A component can be replaced by performing the removal procedure in reverse order.

Recommended Tools

The procedures in this document may require the following tools:

- 1 Small flat-blade screwdriver
- 1 Phillips screwdriver
- 1 Flash BIOS update program floppy disk or CD

Turning Off Your Computer

➡ **NOTICE:** To avoid losing data, save and close any open files and exit any open programs before you turn off your computer.

1. Shut down the operating system:
 - a. Save and close any open files, exit any open programs, click the **Start** button, and then click **Turn Off Computer**.
 - b. In the **Turn off computer** window, click **Turn off**.
The computer turns off after the operating system shutdown process finishes.
2. Ensure that the computer and any attached devices are turned off. If your computer and attached devices did not automatically turn off when you shut down your operating system, turn them off now.

Before Working Inside Your Computer

Use the following safety guidelines to help protect your computer from potential damage and to help ensure your own personal safety.

⚠ **CAUTION:** Before you begin any of the procedures in this section, follow the safety instructions in the *Product Information Guide*.

⚠ **CAUTION:** Handle components and cards with care. Do not touch the components or contacts on a card. Hold a card by its edges or by its metal mounting bracket. Hold a component such as a processor by its edges, not by its pins.

➡ **NOTICE:** Only a certified service technician should perform repairs on your computer. Damage due to servicing that is not authorized by Dell is not covered by your warranty.

➡ **NOTICE:** When you disconnect a cable, pull on its connector or on its strain-relief loop, not on the cable itself. Some cables have a connector with locking tabs; if you are disconnecting this type of cable, press in on the locking tabs before you disconnect the cable. As you pull connectors apart, keep them evenly aligned to avoid bending any connector pins. Also, before you connect a cable, ensure that both connectors are correctly oriented and aligned.

To avoid damaging the computer, perform the following steps before you begin working inside the computer.

1. Turn off your computer.

➡ **NOTICE:** To disconnect a network cable, first unplug the cable from your computer and then unplug it from the network wall jack.

2. Disconnect any telephone or telecommunication lines from the computer.
3. Disconnect your computer and all attached devices from their electrical outlets, and then press the power button to ground the system board.

4. If applicable, remove the computer stand (for instructions, see the documentation that came with the stand) and the cable cover, if attached.

 **CAUTION:** To guard against electrical shock, always unplug your computer from the electrical outlet before removing the cover.

5. Remove the computer cover:

- 1 Remove the [mini tower computer cover](#).
- 1 Remove the [small desktop computer cover](#).

 **NOTICE:** Before touching anything inside your computer, ground yourself by touching an unpainted metal surface, such as the metal at the back of the computer. While you work, periodically touch an unpainted metal surface to dissipate any static electricity that could harm internal components.

[Back to Contents Page](#)

Cleaning Your Computer

Dell™ OptiPlex™ 210L User's Guide

 **CAUTION:** Before you begin any of the procedures in this section, follow the safety instructions located in the *Product Information Guide*.

Computer, Keyboard, and Monitor

 **CAUTION:** Before you clean your computer, disconnect the computer from the electrical outlet. Clean your computer with a soft cloth dampened with water. Do not use liquid or aerosol cleaners, which may contain flammable substances.

1. Use a vacuum cleaner with a brush attachment to gently remove dust from the slots and holes on your computer and from between the keys on the keyboard.

 **NOTICE:** Do not wipe the display screen with any soap or alcohol solution. Doing so may damage the antiglare coating.

1. To clean your monitor screen, lightly dampen a soft, clean cloth with water. If possible, use a special screen-cleaning tissue or solution suitable for the monitor's antistatic coating.
1. Wipe the keyboard, computer, and plastic part of the monitor with a soft cleaning cloth moistened with a solution of three parts water and one part dish washing detergent.

Do not soak the cloth or let water drip inside your computer or keyboard.

Mouse

If your screen cursor skips or moves abnormally, clean the mouse. To clean a non-optical mouse:

1. Turn the retainer ring on the underside of your mouse counterclockwise, and then remove the ball.
2. Wipe the ball with a clean, lint-free cloth.
3. Blow carefully into the ball cage to dislodge dust and lint.
4. If the rollers inside the ball cage are dirty, clean the rollers with a cotton swab moistened lightly with isopropyl alcohol.
5. Re-center the rollers in their channels if they are misaligned. Ensure that lint from the swab is not left on the rollers.
6. Replace the ball and retainer ring, and turn the retainer ring clockwise until it clicks into place.

Floppy Drive

 **NOTICE:** Do not attempt to clean drive heads with a swab. You might accidentally misalign the heads, which prevents the drive from operating.

Clean your floppy drive using a commercially available cleaning kit. These kits contain pretreated floppy disks to remove contaminants that accumulate during normal operation.

CDs and DVDs

 **NOTICE:** Always use compressed air to clean the lens in the CD/DVD drive, and follow the instructions that come with the compressed air. Never touch the lens in the drive.

If you notice problems, such as skipping, with the playback quality of your CDs or DVDs, try cleaning the discs.

1. Hold the disc by its outer edge. You can also touch the inside edge of the center hole.

 **NOTICE:** To prevent damaging the surface, do not wipe in a circular motion around the disc.

2. With a soft, lint-free cloth, gently wipe the bottom of the disc (the unlabeled side) in a straight line from the center to the outer edge of the disc.

For stubborn dirt, try using water or a diluted solution of water and mild soap. You can also purchase commercial products that clean discs and provide

some protection from dust, fingerprints, and scratches. Cleaning products for CDs are safe to use on DVDs.

[Back to Contents Page](#)

Replacing the Computer Cover

Dell™ OptiPlex™ 210L User's Guide

 **CAUTION:** Before you begin any of the procedures in this section, follow the safety instructions in the *Product Information Guide*.

1. Ensure that all cables are connected, and fold cables out of the way.

Gently pull the power cables toward you so that they do not get caught underneath the drives.

2. Ensure that no tools or extra parts are left inside the computer.

3. To replace the cover:

- a. Align the bottom of the cover with the hinge tabs located along the bottom edge of the computer.
- b. Using the hinge tabs as leverage, rotate the cover downward to close it.
- c. Snap the cover into place by pulling back on the cover release latch and then releasing the latch when the cover is properly seated.
- d. Ensure that the cover is seated correctly before moving the computer.

 **NOTICE:** To connect a network cable, first plug the cable into the network wall jack and then plug it into the computer.



4. Attach the computer stand (if applicable). For instructions, see the documentation that came with the stand.
5. Connect your computer and devices to electrical outlets, and turn them on.



Finding Information

Dell™ OptiPlex™ 210L User's Guide

 **NOTE:** Some features may not be available for your computer or in certain countries.

 **NOTE:** Additional information may ship with your computer.

What Are You Looking For?	Find It Here
<ul style="list-style-type: none"> 1 A diagnostic program for my computer 1 Drivers for my computer 1 My computer documentation 1 My device documentation 1 Desktop System Software (DSS) 	<p>Drivers and Utilities CD (also known as ResourceCD)</p> <p>Documentation and drivers are already installed on your computer. You can use the CD to run the Dell Diagnostics or access your documentation.</p>  <p>Readme files may be included on your CD to provide last-minute updates about technical changes to your computer or advanced technical-reference material for technicians or experienced users.</p> <p>NOTE: Drivers and documentation updates can be found at support.dell.com.</p> <p>NOTE: The <i>Drivers and Utilities</i> CD is optional and may not ship with your computer.</p>
<ul style="list-style-type: none"> 1 How to set up my computer 1 Basic troubleshooting information 1 How to run the Dell Diagnostics 1 Error codes and diagnostic lights 1 Tools and utilities 1 How to remove and install parts 	<p>Quick Reference Guide</p>  <p>NOTE: The <i>Quick Reference Guide</i> is optional and may not ship with your computer.</p> <p>NOTE: This document is available as a PDF at support.dell.com.</p>
<ul style="list-style-type: none"> 1 Warranty information 1 Terms and Conditions (U.S. only) 1 Safety instructions 1 Regulatory information 1 Ergonomics information 1 End User License Agreement 	<p>Dell™ Product Information Guide</p> 
<ul style="list-style-type: none"> 1 How to remove and replace parts 1 Specifications 1 How to configure system settings 1 How to troubleshoot and solve problems 	<p>User's Guide</p> <p><i>Microsoft® Windows® XP Help and Support Center</i></p>

	<ol style="list-style-type: none"> 1. Click the Start button and click Help and Support. 2. Click User's and system guides and click User's guides. <p>The <i>User's Guide</i> is also available on the optional <i>Drivers and Utilities CD (Resource CD)</i>.</p>
<ul style="list-style-type: none"> 1 Service Tag and Express Service Code 1 Microsoft Windows License Label 	<p>Service Tag and Microsoft Windows License</p> <p>These labels are located on your computer.</p>  <ol style="list-style-type: none"> 1 Use the Service Tag to identify your computer when you use support.dell.com or contact technical support. 1 Enter the Express Service Code to direct your call when contacting technical support.
<ul style="list-style-type: none"> 1 Solutions — Troubleshooting hints and tips, articles from technicians, online courses, frequently asked questions 1 Community — Online discussion with other Dell customers 1 Upgrades — Upgrade information for components, such as memory, the hard drive, and the operating system 1 Customer Care — Contact information, service call and order status, warranty, and repair information 1 Service and support — Service call status and support history, service contract, online discussions with technical support 1 Reference — Computer documentation, details on my computer configuration, product specifications, and white papers 1 Downloads — Certified drivers, patches, and software updates 1 Desktop System Software (DSS) — If you reinstall the operating system for your computer, you should also reinstall the DSS utility. DSS provides critical updates for your operating system and support for Dell™ 3.5-inch USB floppy drives, Intel® Pentium® M processors, optical drives, and USB devices. DSS is necessary for correct operation of your Dell computer. The software automatically detects your computer and operating system and installs the updates appropriate for your configuration. 	<p>Dell Support Website — support.dell.com</p> <p>NOTE: Select your region to view the appropriate support site.</p> <p>NOTE: Corporate, government, and education customers can also use the customized Dell Premier Support website at premier.support.dell.com. The website may not be available in all regions.</p>
<ul style="list-style-type: none"> 1 How to use Windows XP 1 Documentation for my computer 1 Documentation for devices (such as a modem) 	<p>Windows Help and Support Center</p> <ol style="list-style-type: none"> 1. Click the Start button and click Help and Support. 2. Type a word or phrase that describes your problem and click the arrow icon. 3. Click the topic that describes your problem. 4. Follow the instructions on the screen.
<ul style="list-style-type: none"> 1 How to reinstall my operating system 	<p>Operating System CD</p> <p>The operating system is already installed on your computer. To reinstall your operating system, use the <i>Operating System CD</i>. See "Reinstalling Microsoft Windows XP" for instructions.</p> <p>After you reinstall your operating system, use the optional <i>Drivers and Utilities CD (Resource CD)</i> to reinstall drivers for the devices that came with your computer.</p>  <p>Your operating system product key label is located on your computer.</p> <p>NOTE: The color of your CD varies based on the operating system you ordered.</p> <p>NOTE: The <i>Operating System CD</i> is optional and may not ship with your computer.</p>

[Back to Contents Page](#)

Getting Help

Dell™ OptiPlex™ 210L User's Guide

- [Technical Assistance](#)
 - [Problems With Your Order](#)
 - [Product Information](#)
 - [Returning Items for Warranty Repair or Credit](#)
 - [Before You Call](#)
 - [Contacting Dell](#)
-

Technical Assistance

If you need help with a technical problem, Dell is ready to assist you.

 **CAUTION:** If you need to remove the computer covers, first disconnect the computer power and modem cables from all electrical outlets.

1. Complete the procedures in "[Solving Problems](#)."
2. Run the [Dell Diagnostics](#).
3. Make a copy of the [Diagnostics Checklist](#) and fill it out.
4. Use Dell's extensive suite of online services available at Dell Support (support.dell.com) for help with installation and troubleshooting procedures.
5. If the preceding steps have not resolved the problem, contact Dell.

NOTE: Call technical support from a telephone near or at the computer so that technical support can assist you with any necessary procedures.

NOTE: Dell's Express Service Code system may not be available in all countries.

When prompted by Dell's automated telephone system, enter your Express Service Code to route the call directly to the proper support personnel. If you do not have an Express Service Code, open the **Dell Accessories** folder, double-click the **Express Service Code** icon, and follow the directions.

For instructions on using the technical support service, see "[Technical Support Service](#)."

NOTE: Some of the following services are not always available in all locations outside the continental U.S. Call your local Dell representative for information on availability.

Online Services

You can access Dell Support at support.dell.com. Select your region on the **WELCOME TO DELL SUPPORT** page, and fill in the requested details to access help tools and information.

You can contact Dell electronically using the following addresses:

- 1 World Wide Web

www.dell.com/

www.dell.com/ap/ (Asian/Pacific countries only)

www.dell.com/jp (Japan only)

www.euro.dell.com (Europe only)

www.dell.com/la/ (Latin American countries)

www.dell.ca (Canada only)

- 1 Anonymous file transfer protocol (FTP)

ftp.dell.com/

Log in as user: `anonymous`, and use your e-mail address as your password.

- 1 Electronic Support Service

mobile_support@us.dell.com

support@us.dell.com

apsupport@dell.com (Asian/Pacific countries only)

support.jp.dell.com (Japan only)

support.euro.dell.com (Europe only)

1 Electronic Quote Service

sales@dell.com

apmarketing@dell.com (Asian/Pacific countries only)

sales_canada@dell.com (Canada only)

1 Electronic Information Service

info@dell.com

AutoTech Service

Dell's automated technical support service—AutoTech—provides recorded answers to the questions most frequently asked by Dell customers about their portable and desktop computers.

When you call AutoTech, use your touch-tone telephone to select the subjects that correspond to your questions.

The AutoTech service is available 24 hours a day, 7 days a week. You can also access this service through the technical support service. For the telephone number to call, see the [contact numbers](#) for your region.

Automated Order-Status Service

To check on the status of any Dell™ products that you have ordered, you can go to [support.dell.com](#), or you can call the automated order-status service. A recording prompts you for the information needed to locate and report on your order. For the telephone number to call, see the [contact numbers](#) for your region.

Technical Support Service

Dell's technical support service is available 24 hours a day, 7 days a week, to answer your questions about Dell hardware. Our technical support staff uses computer-based diagnostics to provide fast, accurate answers.

To contact Dell's technical support service, see "[Technical Assistance](#)" and then call the number for your country as listed in "[Contacting Dell](#)."

Problems With Your Order

If you have a problem with your order, such as missing parts, wrong parts, or incorrect billing, contact Dell for customer assistance. Have your invoice or packing slip handy when you call. For the telephone number to call, see the [contact numbers](#) for your region.

Product Information

If you need information about additional products available from Dell, or if you would like to place an order, visit the Dell website at [www.dell.com](#). For the telephone number to call to speak to a sales specialist, see the [contact numbers](#) for your region.

Returning Items for Warranty Repair or Credit

Prepare all items being returned, whether for repair or credit, as follows:

1. Call Dell to obtain a Return Material Authorization Number, and write it clearly and prominently on the outside of the box.

For the telephone number to call, see the [contact numbers](#) for your region.

2. Include a copy of the invoice and a letter describing the reason for the return.
3. Include a copy of the [Diagnostics Checklist](#) indicating the tests you have run and any error messages reported by the Dell Diagnostics.
4. Include any accessories that belong with the item(s) being returned (power cables, software floppy disks, guides, and so on) if the return is for credit.

- Pack the equipment to be returned in the original (or equivalent) packing materials.

You are responsible for paying shipping expenses. You are also responsible for insuring any product returned, and you assume the risk of loss during shipment to Dell. Collect On Delivery (C.O.D.) packages are not accepted.

Returns that are missing any of the preceding requirements will be refused at Dell's receiving dock and returned to you.

Before You Call

NOTE: Have your Express Service Code ready when you call. The code helps Dell's automated-support telephone system direct your call more efficiently.

Remember to fill out the [Diagnostics Checklist](#). If possible, turn on your computer before you call Dell for technical assistance and call from a telephone at or near the computer. You may be asked to type some commands at the keyboard, relay detailed information during operations, or try other troubleshooting steps possible only at the computer itself. Ensure that the computer documentation is available.

 **CAUTION:** Before working inside your computer, read the safety instructions in your *Product Information Guide*.

Diagnostics Checklist
Name:
Date:
Address:
Phone number:
Service Tag (bar code on the back of the computer):
Express Service Code:
Return Material Authorization Number (if provided by Dell support technician):
Operating system and version:
Devices:
Expansion cards:
Are you connected to a network? Yes No
Network, version, and network adapter:
Programs and versions:
See your operating system documentation to determine the contents of the system's start-up files. If the computer is connected to a printer, print each file. Otherwise, record the contents of each file before calling Dell.
Error message, beep code, or diagnostic code:
Description of problem and troubleshooting procedures you performed:

Contacting Dell

To contact Dell electronically, you can access the following websites:

- www.dell.com
- support.dell.com (technical support)
- premiersupport.dell.com (technical support for educational, government, healthcare, and medium/large business customers, including Premier, Platinum, and Gold customers)

For specific web addresses for your country, find the appropriate country section in the table below.

 **NOTE:** Toll-free numbers are for use within the country for which they are listed.

NOTE: In certain countries, technical support specific to Dell Inspiron™ XPS computers is available at a separate telephone number listed for participating countries. If you do not see a telephone number listed that is specific for Inspiron XPS computers, you may contact Dell through the technical support number listed and your call will be routed appropriately.

When you need to contact Dell, use the electronic addresses, telephone numbers, and codes provided in the following table. If you need assistance in determining which codes to use, contact a local or an international operator.

Country (City) International Access Code Country Code City Code	Department Name or Service Area, Website and E-Mail Address	Area Codes, Local Numbers, and Toll-Free Numbers
Anguilla	General Support	toll-free: 800-335-0031
Antigua and Barbuda	General Support	1-800-805-5924
	Website: www.dell.com.ar	

Argentina (Buenos Aires) International Access Code: 00 Country Code: 54 City Code: 11	E-mail: us_latin_services@dell.com	
	E-mail for desktop and portable computers: la-techsupport@dell.com	
	E-mail for servers and EMC® storage products: la_enterprise@dell.com	
	Customer Care	toll-free: 0-800-444-0730
	Tech Support	toll-free: 0-800-444-0733
Aruba	Tech Support Services	toll-free: 0-800-444-0724
	Sales	0-810-444-3355
	General Support	toll-free: 800-1578
	E-mail (Australia): au_tech_support@dell.com	
	E-mail (New Zealand): nz_tech_support@dell.com	
Australia (Sydney) International Access Code: 0011 Country Code: 61 City Code: 2	Home and Small Business	1-300-655-533
	Government and Business	toll-free: 1-800-633-559
	Preferred Accounts Division (PAD)	toll-free: 1-800-060-889
	Customer Care	toll-free: 1-800-819-339
	Technical Support (portables and desktops)	toll-free: 1-300-655-533
	Technical Support (servers and workstations)	toll-free: 1-800-733-314
	Corporate Sales	toll-free: 1-800-808-385
	Transaction Sales	toll-free: 1-800-808-312
	Fax	toll-free: 1-800-818-341
	Austria (Vienna) International Access Code: 900 Country Code: 43 City Code: 1	Website: support.euro.dell.com
E-mail: tech_support_central_europe@dell.com		
Technical Support for Inspiron XPS computers only		0820 240 530 81
Home/Small Business Sales		0820 240 530 00
Home/Small Business Fax		0820 240 530 49
Home/Small Business Customer Care		0820 240 530 14
Preferred Accounts/Corporate Customer Care		0820 240 530 16
Home/Small Business Technical Support		0820 240 530 14
Preferred Accounts/Corporate Technical Support		0660 8779
Switchboard		0820 240 530 00
Bahamas	General Support	toll-free: 1-866-278-6818
Barbados	General Support	1-800-534-3066
Belgium (Brussels) International Access Code: 00 Country Code: 32 City Code: 2	Website: support.euro.dell.com	
	E-mail for French-speaking Customers: support.euro.dell.com/be/fr/emaildell/	
	Technical Support for Inspiron XPS computers only	02 481 92 96
	Technical Support for all other Dell computers	02 481 92 88
	Technical Support Fax	02 481 92 95
	Customer Care	02 713 15 .65
	Corporate Sales	02 481 91 00
	Fax	02 481 92 99
Switchboard	02 481 91 00	
Bermuda	General Support	1-800-342-0671
Bolivia	General Support	toll-free: 800-10-0238
Brazil International Access Code: 00 Country Code: 55 City Code: 51	Website: www.dell.com/br	
	Customer Support, Technical Support	0800 90 3355
	Technical Support Fax	51 481 5470
	Customer Care Fax	51 481 5480
	Sales	0800 90 3390
British Virgin Islands	General Support	toll-free: 1-866-278-6820
Brunei Country Code: 673	Customer Technical Support (Penang, Malaysia)	604 633 4966
	Customer Service (Penang, Malaysia)	604 633 4949
	Transaction Sales (Penang, Malaysia)	604 633 4955
Canada (North York, Ontario)	Online Order Status: www.dell.ca/ostatus	
	AutoTech (automated technical support)	toll-free: 1-800-247-9362
	Customer Care (Home Sales/Small Business)	toll-free: 1-800-847-4096
	Customer Care (med./large business, government)	toll-free: 1-800-326-9463
	Technical Support (Home Sales/Small Business)	toll-free: 1-800-847-4096

International Access Code: 011	Technical Support (med./large bus., government)	toll-free: 1-800-387-5757
	Technical Support (printers, projectors, televisions, handhelds, digital jukebox, and wireless)	1-877-335-5767
	Sales (Home Sales/Small Business)	toll-free: 1-800-387-5752
	Sales (med./large bus., government)	toll-free: 1-800-387-5755
	Spare Parts Sales & Extended Service Sales	1 866 440 3355
Cayman Islands	General Support	1-800-805-7541
Chile (Santiago) Country Code: 56 City Code: 2	Sales, Customer Support, and Technical Support	toll-free: 1230-020-4823
China (Xiamen) Country Code: 86 City Code: 592	Technical Support website: support.dell.com.cn	
	Technical Support E-mail: cn_support@dell.com	
	Customer Care E-mail: customer_cn@dell.com	
	Technical Support Fax	592 818 1350
	Technical Support (Dell™ Dimension™ and Inspiron)	toll-free: 800 858 2969
	Technical Support (OptiPlex™, Latitude™, and Dell Precision™)	toll-free: 800 858 0950
	Technical Support (servers and storage)	toll-free: 800 858 0960
	Technical Support (projectors, PDAs, switches, routers, and so on)	toll-free: 800 858 2920
	Technical Support (printers)	toll-free: 800 858 2311
	Customer Care	toll-free: 800 858 2060
	Customer Care Fax	592 818 1308
	Home and Small Business	toll-free: 800 858 2222
	Preferred Accounts Division	toll-free: 800 858 2557
	Large Corporate Accounts GCP	toll-free: 800 858 2055
	Large Corporate Accounts Key Accounts	toll-free: 800 858 2628
	Large Corporate Accounts North	toll-free: 800 858 2999
	Large Corporate Accounts North Government and Education	toll-free: 800 858 2955
	Large Corporate Accounts East	toll-free: 800 858 2020
	Large Corporate Accounts East Government and Education	toll-free: 800 858 2669
	Large Corporate Accounts Queue Team	toll-free: 800 858 2572
Large Corporate Accounts South	toll-free: 800 858 2355	
Large Corporate Accounts West	toll-free: 800 858 2811	
Large Corporate Accounts Spare Parts	toll-free: 800 858 2621	
Colombia	General Support	980-9-15-3978
Costa Rica	General Support	0800-012-0435
Czech Republic (Prague) International Access Code: 00 Country Code: 420	Website: support.euro.dell.com	
	E-mail: czech_dell@dell.com	
	Technical Support	22537 2727
	Customer Care	22537 2707
	Fax	22537 2714
	Tech Fax	22537 2728
Switchboard	22537 2711	
Denmark (Copenhagen) International Access Code: 00 Country Code: 45	Website: support.euro.dell.com	
	E-mail: support.euro.dell.com/dk/da/emaildell/	
	Technical Support for Inspiron XPS computers only	7010 0074
	Technical Support for all other Dell computers	7023 0182
	Customer Care (Relational)	7023 0184
	Home/Small Business Customer Care	3287 5505
	Switchboard (Relational)	3287 1200
	Switchboard Fax (Relational)	3287 1201
Switchboard (Home/Small Business)	3287 5000	
Switchboard Fax (Home/Small Business)	3287 5001	
Dominica	General Support	toll-free: 1-866-278-6821
Dominican Republic	General Support	1-800-148-0530
Ecuador	General Support	toll-free: 999-119
El Salvador	General Support	01-899-753-0777
Finland (Helsinki)	Website: support.euro.dell.com	

International Access Code: 990 Country Code: 358 City Code: 9	E-mail: support.euro.dell.com/fi/fi/emaildell/	
	Technical Support	09 253 313 60
	Customer Care	09 253 313 38
	Fax	09 253 313 99
	Switchboard	09 253 313 00
France (Paris) (Montpellier) International Access Code: 00 Country Code: 33 City Codes: (1) (4)	Website: support.euro.dell.com	
	E-mail: support.euro.dell.com/fr/fr/emaildell/	
	Home and Small Business	
	Technical Support for Inspiron XPS computers only	0825 387 129
	Technical Support for all other Dell computers	0825 387 270
	Customer Care	0825 823 833
	Switchboard	0825 004 700
	Switchboard (calls from outside of France)	04 99 75 40 00
	Sales	0825 004 700
	Fax	0825 004 701
	Fax (calls from outside of France)	04 99 75 40 01
	Corporate	
	Technical Support	0825 004 719
	Customer Care	0825 338 339
	Switchboard	01 55 94 71 00
Sales	01 55 94 71 00	
Fax	01 55 94 71 01	
Germany (Langen) International Access Code: 00 Country Code: 49 City Code: 6103	Website: support.euro.dell.com	
	E-mail: tech_support_central_europe@dell.com	
	Technical Support for Inspiron XPS computers only	06103 766-7222
	Technical Support for all other Dell computers	06103 766-7200
	Home/Small Business Customer Care	0180-5-224400
	Global Segment Customer Care	06103 766-9570
	Preferred Accounts Customer Care	06103 766-9420
	Large Accounts Customer Care	06103 766-9560
	Public Accounts Customer Care	06103 766-9555
	Switchboard	06103 766-7000
Greece International Access Code: 00 Country Code: 30	Website: support.euro.dell.com	
	E-mail: support.euro.dell.com/gr/en/emaildell/	
	Technical Support	00800-44 14 95 18
	Gold Service Technical Support	00800-44 14 00 83
	Switchboard	2108129810
	Gold Service Switchboard	2108129811
	Sales	2108129800
Fax	2108129812	
Grenada	General Support	toll-free: 1-866-540-3355
Guatemala	General Support	1-800-999-0136
Guyana	General Support	toll-free: 1-877-270-4609
Hong Kong International Access Code: 001 Country Code: 852	Website: support.ap.dell.com	
	Technical Support E-mail: apsupport@dell.com	
	Technical Support (Dimension and Inspiron)	2969 3188
	Technical Support (OptiPlex, Latitude, and Dell Precision)	2969 3191
	Technical Support (PowerApp™, PowerEdge™, PowerConnect™, and PowerVault™)	2969 3196
	Customer Care	3416 0910
	Large Corporate Accounts	3416 0907
	Global Customer Programs	3416 0908
	Medium Business Division	3416 0912
	Home and Small Business Division	2969 3105
India	Technical Support	1600 33 8045
	Sales (Large Corporate Accounts)	1600 33 8044
	Sales (Home and Small Business)	1600 33 8046
	Website: support.euro.dell.com	
	E-mail: dell_direct_support@dell.com	

Ireland (Cherrywood) International Access Code: 16 Country Code: 353 City Code: 1	Technical Support for Inspiron XPS computers only	1850 200 722
	Technical Support for all other Dell computers	1850 543 543
	U.K. Technical Support (dial within U.K. only)	0870 908 0800
	Home User Customer Care	01 204 4014
	Small Business Customer Care	01 204 4014
	U.K. Customer Care (dial within U.K. only)	0870 906 0010
	Corporate Customer Care	1850 200 982
	Corporate Customer Care (dial within U.K. only)	0870 907 4499
	Ireland Sales	01 204 4444
	U.K. Sales (dial within U.K. only)	0870 907 4000
	Fax/Sales Fax	01 204 0103
	Switchboard	01 204 4444
	Italy (Milan) International Access Code: 00 Country Code: 39 City Code: 02	Website: support.euro.dell.com
E-mail: support.euro.dell.com/it/it/emaildell/		
Home and Small Business		
Technical Support		02 577 826 90
Customer Care		02 696 821 14
Fax		02 696 821 13
Switchboard		02 696 821 12
Corporate		
Technical Support		02 577 826 90
Customer Care		02 577 825 55
Fax		02 575 035 30
Switchboard	02 577 821	
Jamaica	General Support (dial from within Jamaica only)	1-800-682-3639
Japan (Kawasaki) International Access Code: 001 Country Code: 81 City Code: 44	Website: support.jp.dell.com	
	Technical Support (servers)	toll-free: 0120-198-498
	Technical Support outside of Japan (servers)	81-44-556-4162
	Technical Support (Dimension and Inspiron)	toll-free: 0120-198-226
	Technical Support outside of Japan (Dimension and Inspiron)	81-44-520-1435
	Technical Support (Dell Precision, OptiPlex, and Latitude)	toll-free: 0120-198-433
	Technical Support outside of Japan (Dell Precision, OptiPlex, and Latitude)	81-44-556-3894
	Technical Support (PDAs, projectors, printers, routers)	toll-free: 0120-981-690
	Technical Support outside of Japan (PDAs, projectors, printers, routers)	81-44-556-3468
	Faxbox Service	044-556-3490
	24-Hour Automated Order Service	044-556-3801
	Customer Care	044-556-4240
	Business Sales Division (up to 400 employees)	044-556-1465
	Preferred Accounts Division Sales (over 400 employees)	044-556-3433
	Large Corporate Accounts Sales (over 3500 employees)	044-556-3430
	Public Sales (government agencies, educational institutions, and medical institutions)	044-556-1469
	Global Segment Japan	044-556-3469
Individual User	044-556-1760	
Switchboard	044-556-4300	
Korea (Seoul) International Access Code: 001 Country Code: 82 City Code: 2	Technical Support	toll-free: 080-200-3800
	Sales	toll-free: 080-200-3600
	Customer Service (Penang, Malaysia)	604 633 4949
	Fax	2194-6202
	Switchboard	2194-6000
Latin America	Technical Support (Electronics and Accessories)	toll-free: 080-200-3801
	Customer Technical Support (Austin, Texas, U.S.A.)	512 728-4093
	Customer Service (Austin, Texas, U.S.A.)	512 728-3619
	Fax (Technical Support and Customer Service) (Austin, Texas, U.S.A.)	512 728-3883
	Sales (Austin, Texas, U.S.A.)	512 728-4397
	SalesFax (Austin, Texas, U.S.A.)	512 728-4600 or 512 728-3772
	Website: support.euro.dell.com	
	E-mail: tech_be@dell.com	

Luxembourg International Access Code: 00 Country Code: 352	Technical Support (Brussels, Belgium)	3420808075
	Home/Small Business Sales (Brussels, Belgium)	toll-free: 080016884
	Corporate Sales (Brussels, Belgium)	02 481 91 00
	Customer Care (Brussels, Belgium)	02 481 91 19
	Fax (Brussels, Belgium)	02 481 92 99
	Switchboard (Brussels, Belgium)	02 481 91 00
Macao Country Code: 853	Technical Support	toll-free: 0800 105
	Customer Service (Xiamen, China)	34 160 910
	Transaction Sales (Xiamen, China)	29 693 115
Malaysia (Penang) International Access Code: 00 Country Code: 60 City Code: 4	Website: support.ap.dell.com	
	Technical Support (Dell Precision, OptiPlex, and Latitude)	toll-free: 1 800 88 0193
	Technical Support (Dimension, Inspiron, and Electronics and Accessories)	toll-free: 1 800 88 1306
	Technical Support (PowerApp, PowerEdge, PowerConnect, and PowerVault)	toll-free: 1800 88 1386
	Customer Service (Penang, Malaysia)	04 633 4949
	Transaction Sales	toll-free: 1 800 888 202
	Corporate Sales	toll-free: 1 800 888 213
Mexico International Access Code: 00 Country Code: 52	Customer Technical Support	001-877-384-8979 or 001-877-269-3383
	Sales	50-81-8800 or 01-800-888-3355
	Customer Service	001-877-384-8979 or 001-877-269-3383
	Main	50-81-8800 or 01-800-888-3355
Montserrat	General Support	toll-free: 1-866-278-6822
Netherlands Antilles	General Support	001-800-882-1519
Netherlands (Amsterdam) International Access Code: 00 Country Code: 31 City Code: 20	Website: support.euro.dell.com	
	Technical Support for Inspiron XPS computers only	020 674 45 94
	Technical Support for all other Dell computers	020 674 45 00
	Technical Support Fax	020 674 47 66
	Home/Small Business Customer Care	020 674 42 00
	Relational Customer Care	020 674 4325
	Home/Small Business Sales	020 674 55 00
	Relational Sales	020 674 50 00
	Home/Small Business Sales Fax	020 674 47 75
	Relational Sales Fax	020 674 47 50
	Switchboard	020 674 50 00
Switchboard Fax	020 674 47 50	
New Zealand International Access Code: 00 Country Code: 64	E-mail (New Zealand): nz_tech_support@dell.com	
	E-mail (Australia): au_tech_support@dell.com	
	Technical Support (for desktop and portable computers)	toll-free: 0800 446 255
	Technical Support (for servers and workstations)	toll-free: 0800 443 563
	Home and Small Business	0800 446 255
	Government and Business	0800 444 617
	Sales	0800 441 567
Fax	0800 441 566	
Nicaragua	General Support	001-800-220-1006
Norway (Lysaker) International Access Code: 00 Country Code: 47	Website: support.euro.dell.com	
	E-mail: support.euro.dell.com/no/no/emaildell/	
	Technical Support	671 16882
	Relational Customer Care	671 17575
	Home/Small Business Customer Care	23162298
	Switchboard	671 16800
	Fax Switchboard	671 16865
Panama	General Support	001-800-507-0962
Peru	General Support	0800-50-669
	Website: support.euro.dell.com	

Poland (Warsaw) International Access Code: 011 Country Code: 48 City Code: 22	E-mail: pl_support_tech@dell.com	
	Customer Service Phone	57 95 700
	Customer Care	57 95 999
	Sales	57 95 999
	Customer Service Fax	57 95 806
	Reception Desk Fax	57 95 998
	Switchboard	57 95 999
Portugal International Access Code: 00 Country Code: 351	Website: support.euro.dell.com	
	E-mail: support.euro.dell.com/pt/en/emailldell/	
	Technical Support	707200149
	Customer Care	800 300 413
	Sales	800 300 410 or 800 300 411 or 800 300 412 or 21 422 07 10
	Fax	21 424 01 12
Puerto Rico	General Support	1-800-805-7545
St. Kitts and Nevis	General Support	toll-free: 1-877-441-4731
St. Lucia	General Support	1-800-882-1521
St. Vincent and the Grenadines	General Support	toll-free: 1-877-270-4609
Singapore (Singapore) International Access Code: 005 Country Code: 65	Website: support.ap.dell.com	
	Technical Support (Dimension, Inspiron, and Electronics and Accessories)	toll-free: 1800 394 7430
	Technical Support (OptiPlex, Latitude, and Dell Precision)	toll-free: 1800 394 7488
	Technical Support (PowerApp, PowerEdge, PowerConnect, and PowerVault)	toll-free: 1800 394 7478
	Customer Service (Penang, Malaysia)	604 633 4949
	Transaction Sales	toll-free: 1 800 394 7412
	Corporate Sales	toll-free: 1 800 394 7419
Slovakia (Prague) International Access Code: 00 Country Code: 421	Website: support.euro.dell.com	
	E-mail: czech_dell@dell.com	
	Technical Support	02 5441 5727
	Customer Care	420 22537 2707
	Fax	02 5441 8328
	Tech Fax	02 5441 8328
	Switchboard (Sales)	02 5441 7585
South Africa (Johannesburg) International Access Code: 09/091 Country Code: 27 City Code: 11	Website: support.euro.dell.com	
	E-mail: dell_za_support@dell.com	
	Gold Queue	011 709 7713
	Technical Support	011 709 7710
	Customer Care	011 709 7707
	Sales	011 709 7700
	Fax	011 706 0495
	Switchboard	011 709 7700
Southeast Asian and Pacific Countries	Customer Technical Support, Customer Service, and Sales (Penang, Malaysia)	604 633 4810
Spain (Madrid) International Access Code: 00 Country Code: 34 City Code: 91	Website: support.euro.dell.com	
	E-mail: support.euro.dell.com/es/es/emailldell/	
	Home and Small Business	
	Technical Support	902 100 130
	Customer Care	902 118 540
	Sales	902 118 541
	Switchboard	902 118 541
	Fax	902 118 539
	Corporate	
	Technical Support	902 100 130
	Customer Care	902 115 236
	Switchboard	91 722 92 00
	Fax	91 722 95 83
Sweden (Upplands Vasby) International Access Code: 00	Website: support.euro.dell.com	
	E-mail: support.euro.dell.com/se/sv/emailldell/	
	Technical Support	08 590 05 199
	Relational Customer Care	08 590 05 642

Country Code: 46	Home/Small Business Customer Care	08 587 70 527	
City Code: 8	Employee Purchase Program (EPP) Support	20 140 14 44	
	Technical Support Fax	08 590 05 594	
	Sales	08 590 05 185	
Switzerland (Geneva)	Website: support.euro.dell.com		
	E-mail: Tech_support_central_Europe@dell.com		
	E-mail for French-speaking HSB and Corporate Customers: support.euro.dell.com/ch/fr/emaildell/		
	International Access Code: 00	Technical Support (Home and Small Business)	0844 811 411
	Country Code: 41	Technical Support (Corporate)	0844 822 844
		Customer Care (Home and Small Business)	0848 802 202
	City Code: 22	Customer Care (Corporate)	0848 821 721
		Fax	022 799 01 90
Switchboard	022 799 01 01		
Taiwan	Website: support.ap.dell.com		
	E-mail: ap_support@dell.com		
	International Access Code: 002	Technical Support (OptiPlex, Latitude, Inspiron, Dimension, and Electronics and Accessories)	toll-free: 00801 86 1011
	Country Code: 886	Technical Support (PowerApp, PowerEdge, PowerConnect, and PowerVault)	toll-free: 00801 60 1256
		Transaction Sales	toll-free: 00801 65 1228
		Corporate Sales	toll-free: 00801 651 227
Thailand	Website: support.ap.dell.com		
	Technical Support (OptiPlex, Latitude, and Dell Precision)	toll-free: 1800 0060 07	
	International Access Code: 001	Technical Support (PowerApp, PowerEdge, PowerConnect, and PowerVault)	toll-free: 1800 0600 09
	Country Code: 66	Customer Service (Penang, Malaysia)	604 633 4949
		Corporate Sales	toll-free: 1800 006 009
Transaction Sales	toll-free: 1800 006 006		
Trinidad/Tobago	General Support	1-800-805-8035	
Turks and Caicos Islands	General Support	toll-free: 1-866-540-3355	
U.K. (Bracknell)	Website: support.euro.dell.com		
	Customer Care website: support.euro.dell.com/uk/en/ECare/Form/Home.asp		
	E-mail: dell_direct_support@dell.com		
	International Access Code: 00	Technical Support (Corporate/Preferred Accounts/PAD [1000+ employees])	0870 908 0500
		Technical Support (direct and general)	0870 908 0800
	Country Code: 44	Global Accounts Customer Care	01344 373 186
		Home and Small Business Customer Care	0870 906 0010
	City Code: 1344	Corporate Customer Care	01344 373 185
		Preferred Accounts (500-5000 employees) Customer Care	0870 906 0010
		Central Government Customer Care	01344 373 193
		Local Government & Education Customer Care	01344 373 199
		Health Customer Care	01344 373 194
		Home and Small Business Sales	0870 907 4000
	Corporate/Public Sector Sales	01344 860 456	
Home and Small Business Fax	0870 907 4006		
Uruguay	General Support	toll-free: 000-413-598-2521	
U.S.A. (Austin, Texas)	Automated Order-Status Service	toll-free: 1-800-433-9014	
	AutoTech (portable and desktop computers)	toll-free: 1-800-247-9362	
	Consumer (Home and Home Office)		
	Technical Support	toll-free: 1-800-624-9896	
	Customer Service	toll-free: 1-800-624-9897	
	DellNet™ Service and Support	toll-free: 1-877-Dellnet (1-877-335-5638)	
	Employee Purchase Program (EPP) Customers	toll-free: 1-800-695-8133	
	Financial Services website: www.dellfinancialservices.com		
	Financial Services (lease/loans)	toll-free: 1-877-577-3355	
	Financial Services (Dell Preferred Accounts [DPA])	toll-free: 1-800-283-2210	
	Business		
	Customer Service and Technical Support	toll-free: 1-800-822-8965	

International Access Code: 011 Country Code: 1	Employee Purchase Program (EPP) Customers	toll-free: 1-800-695-8133
	Printers and Projectors Technical Support	toll-free: 1-877-459-7298
	Public (government, education, and healthcare)	
	Customer Service and Technical Support	toll-free: 1-800-456-3355
	Employee Purchase Program (EPP) Customers	toll-free: 1-800-234-1490
	Dell Sales	toll-free: 1-800-289-3355 or toll-free: 1-800-879-3355
	Dell Outlet Store (Dell refurbished computers)	toll-free: 1-888-798-7561
	Software and Peripherals Sales	toll-free: 1-800-671-3355
	Spare Parts Sales	toll-free: 1-800-357-3355
	Extended Service and Warranty Sales	toll-free: 1-800-247-4618
	Fax	toll-free: 1-800-727-8320
	Dell Services for the Deaf, Hard-of-Hearing, or Speech-Impaired	toll-free: 1-877-DELLTTY (1-877-335-5889)
	U.S. Virgin Islands	General Support
Venezuela	General Support	8001-3605

[Back to Contents Page](#)

[Back to Contents Page](#)

Glossary

Dell™ OptiPlex™ 210L User's Guide

Terms in this Glossary are provided for informational purposes only and may or may not describe features included with your particular computer.

A

AC — alternating current — The form of electricity that powers your computer when you plug the AC adapter power cable in to an electrical outlet.

ACPI — advanced configuration and power interface — A power management specification that enables Microsoft® Windows® operating systems to put a computer in standby or hibernate mode to conserve the amount of electrical power allocated to each device attached to the computer.

AGP — accelerated graphics port — A dedicated graphics port that allows system memory to be used for video-related tasks. AGP delivers a smooth, true-color video image because of the faster interface between the video circuitry and the computer memory.

antivirus software — A program designed to identify, quarantine, and/or delete viruses from your computer.

APR — advanced port replicator — A docking device that allows you to conveniently use a monitor, keyboard, mouse, and other devices with your portable computer.

ASF — alert standards format — A standard to define a mechanism for reporting hardware and software alerts to a management console. ASF is designed to be platform- and operating system-independent.

B

backup — A copy of a program or data file on a floppy disk, CD, or hard drive. As a precaution, back up the data files from your hard drive regularly.

battery — An internal power source used to operate portable computers when not connected to an AC adapter and an electrical outlet.

battery life span — The length of time (years) during which a portable computer battery is able to be depleted and recharged.

battery operating time — The length of time (minutes or hours) that a portable computer battery holds a charge while powering the computer.

BIOS — basic input/output system — A program (or utility) that serves as an interface between the computer hardware and the operating system. Unless you understand what effect the settings have on the computer, do not change the settings for this program. Also referred to as *system setup*.

bit — The smallest unit of data interpreted by your computer.

Bluetooth™ — A wireless technology standard for short-range (9 m [29 feet]) networking devices that allows for enabled devices to automatically recognize each other.

boot sequence — Specifies the order of the devices from which the computer attempts to boot.

bootable CD — A CD that you can use to start your computer. In case your hard drive is damaged or your computer has a virus, ensure that you always have a bootable CD or floppy disk available. Your *Drivers and Utilities* or Resource CD is a bootable CD.

bootable disk — A disk that you can use to start your computer. In case your hard drive is damaged or your computer has a virus, ensure that you always have a bootable CD or floppy disk available.

bps — bits per second — The standard unit for measuring data transmission speed.

BTU — British thermal unit — A measurement of heat output.

bus — A communication pathway between the components in your computer.

bus speed — The speed, given in MHz, that indicates how fast a bus can transfer information.

byte — The basic data unit used by your computer. A byte is usually equal to 8 bits.

C

C — Celsius — A temperature measurement system where 0° is the freezing point and 100° is the boiling point of water.

cache — A special high-speed storage mechanism which can be either a reserved section of main memory or an independent high-speed storage device. The cache enhances the efficiency of many processor operations.

L1 cache — Primary cache stored inside the processor.

L2 cache — Secondary cache which can either be external to the processor or incorporated into the processor architecture.

carnet — An international customs document that facilitates temporary imports into foreign countries. Also known as a *merchandise passport*.

CD — compact disc — An optical form of storage media, typically used for audio and software programs.

CD drive — A drive that uses optical technology to read data from CDs.

CD player — The software used to play music CDs. The CD player displays a window with buttons that you use to play a CD.

CD-R — CD recordable — A recordable version of a CD. Data can be recorded only once onto a CD-R. Once recorded, the data cannot be erased or written over.

CD-RW — CD rewritable — A rewritable version of a CD. Data can be written to a CD-RW disc, and then erased and written over (rewritten).

CD-RW drive — A drive that can read CDs and write to CD-RW (rewritable CDs) and CD-R (recordable CDs) discs. You can write to CD-RW discs multiple times, but you can write to CD-R discs only once.

CD-RW/DVD drive — A drive, sometimes referred to as a combo drive, that can read CDs and DVDs and write to CD-RW (rewritable CDs) and CD-R (recordable CDs) discs. You can write to CD-RW discs multiple times, but you can write to CD-R discs only once.

clock speed — The speed, given in MHz, that indicates how fast computer components that are connected to the system bus operate.

COA — Certificate of Authenticity — The Windows alpha-numeric code located on a sticker on your computer. You may need the COA to complete the operating system setup or reinstallation. Also referred to as the *Product Key* or *Product ID*.

Control Panel — A Windows utility that allows you to modify operating system and hardware settings, such as display settings.

controller — A chip that controls the transfer of data between the processor and memory or between the processor and devices.

CRIMM — continuity rambus in-line memory module — A special module that has no memory chips and is used to fill unused RIMM slots.

cursor — The marker on a display or screen that shows where the next keyboard, touch pad, or mouse action will occur. It often is a blinking solid line, an underline character, or a small arrow.

D

DDR SDRAM — double-data-rate SDRAM — A type of SDRAM that doubles the data burst cycle, improving system performance.

device — Hardware such as a disk drive, printer, or keyboard that is installed in or connected to your computer.

device driver — See *driver*.

DIN connector — A round, six-pin connector that conforms to DIN (Deutsche Industrie-Norm) standards; it is typically used to connect PS/2 keyboard or mouse cable connectors.

disk striping — A technique for spreading data over multiple disk drives. Disk striping can speed up operations that retrieve data from disk storage. Computers that use disk striping generally allow the user to select the data unit size or stripe width.

DMA — direct memory access — A channel that allows certain types of data transfer between RAM and a device to bypass the processor.

docking device — See *APR*.

DMTF — Distributed Management Task Force — A consortium of hardware and software companies who develop management standards for distributed desktop, network, enterprise, and Internet environments.

domain — A group of computers, programs, and devices on a network that are administered as a unit with common rules and procedures for use by a specific group of users. A user logs on to the domain to gain access to the resources.

DRAM — dynamic random-access memory — Memory that stores information in integrated circuits containing capacitors.

driver — Software that allows the operating system to control a device such as a printer. Many devices do not work properly if the correct driver is not installed in the computer.

DSL — Digital Subscriber Line — A technology that provides a constant, high-speed Internet connection through an analog telephone line.

dual display mode — A display setting that allows you to use a second monitor as an extension of your display. Also referred to as *extended display mode*.

DVD — digital versatile disc — A disc usually used to store movies. DVDs are double-sided, whereas CDs are single-sided. DVD drives read most CD media as well.

DVD drive — A drive that uses optical technology to read data from DVDs and CDs.

DVD player — The software used to watch DVD movies. The DVD player displays a window with buttons that you use to watch a movie.

DVD+RW — DVD rewritable — A rewritable version of a DVD. Data can be written to a DVD+RW disc, and then erased and written over (rewritten). (DVD+RW technology is different from DVD-RW technology.)

DVD+RW drive — A drive that can read DVDs and most CD media and write to DVD+RW (rewritable DVDs) discs.

DVI — digital video interface — A standard for digital transmission between a computer and a digital video display; the DVI adapter works through the computer's integrated graphics.

E

ECC — error checking and correction — A type of memory that includes special circuitry for testing the accuracy of data as it passes in and out of memory.

ECP — extended capabilities port — A parallel connector design that provides improved bidirectional data transmission. Similar to EPP, ECP uses direct memory access to transfer data and often improves performance.

EIDE — enhanced integrated device electronics — An improved version of the IDE interface for hard drives and CD drives.

EMI — electromagnetic interference — Electrical interference caused by electromagnetic radiation.

ENERGY STAR® — Environmental Protection Agency requirements that decrease the overall consumption of electricity.

EPP — enhanced parallel port — A parallel connector design that provides bidirectional data transmission.

ESD — electrostatic discharge — A rapid discharge of static electricity. ESD can damage integrated circuits found in computer and communications equipment.

expansion card — A circuit board that installs in an expansion slot on the system board in some computers, expanding the capabilities of the computer. Examples include video, modem, and sound cards.

expansion slot — A connector on the system board (in some computers) where you insert an expansion card, connecting it to the system bus.

Express Service Code — A numeric code located on a sticker on your Dell™ computer. Use the Express Service Code when contacting Dell for assistance. Express Service Code service may not be available in some countries.

extended display mode — A display setting that allows you to use a second monitor as an extension of your display. Also referred to as *dual display mode*.

extended PC Card — A PC Card that extends beyond the edge of the PC Card slot when installed.

F

Fahrenheit — A temperature measurement system where 32° is the freezing point and 212° is the boiling point of water.

FCC — Federal Communications Commission — A U.S. agency responsible for enforcing communications-related regulations that state how much radiation computers and other electronic equipment can emit.

floppy drive — A disk drive that can read and write to floppy disks.

folder — A term used to describe space on a disk or drive where files are organized and grouped. Files in a folder can be viewed and ordered in various ways, such as alphabetically, by date, and by size.

format — The process that prepares a drive or disk for file storage. When a drive or disk is formatted, the existing information on it is lost.

FSB — front side bus — The data path and physical interface between the processor and RAM.

FTP — file transfer protocol — A standard Internet protocol used to exchange files between computers connected to the Internet.

G

G — gravity — A measurement of weight and force.

GB — gigabyte — A measurement of data storage that equals 1024 MB (1,073,741,824 bytes). When used to refer to hard drive storage, the term is often rounded to 1,000,000,000 bytes.

GHz — gigahertz — A measurement of frequency that equals one thousand million Hz, or one thousand MHz. The speeds for computer processors, buses, and interfaces are often measured in GHz.

graphics mode — A video mode that can be defined as x horizontal pixels by y vertical pixels by z colors. Graphics modes can display an unlimited variety of shapes and fonts.

GUI — graphical user interface — Software that interacts with the user by means of menus, windows, and icons. Most programs that operate on the Windows operating systems are GUIs.

H

hard drive — A drive that reads and writes data on a hard disk. The terms hard drive and hard disk are often used interchangeably.

heat sink — A metal plate on some processors that helps dissipate heat.

help file — A file that contains descriptive or instructional information about a product. Some help files are associated with a particular program, such as *Help* in Microsoft Word. Other help files function as stand-alone reference sources. Help files typically have a filename extension of **.hlp** or **.chm**.

hibernate mode — A power management mode that saves everything in memory to a reserved space on the hard drive and then turns off the computer. When you restart the computer, the memory information that was saved to the hard drive is automatically restored.

HTML — hypertext markup language — A set of codes inserted into an Internet web page intended for display on an Internet browser.

HTTP — hypertext transfer protocol — A protocol for exchanging files between computers connected to the Internet.

Hz — hertz — A unit of frequency measurement that equals 1 cycle per second. Computers and electronic devices are often measured in kilohertz (kHz), megahertz (MHz), gigahertz (GHz), or terahertz (THz).

I

IC — Industry Canada — The Canadian regulatory body responsible for regulating emissions from electronic equipment, much as the FCC does in the United States.

IC — integrated circuit — A semiconductor wafer, or chip, on which thousands or millions of tiny electronic components are fabricated for use in computer, audio, and video equipment.

IDE — integrated device electronics — An interface for mass storage devices in which the controller is integrated into the hard drive or CD drive.

infrared sensor — A port that allows you to transfer data between the computer and infrared-compatible devices without using a cable connection.

integrated — Usually refers to components that are physically located on the computer's system board. Also referred to as *built-in*.

I/O — input/output — An operation or device that enters and extracts data from your computer. Keyboards and printers are I/O devices.

I/O address — An address in RAM that is associated with a specific device (such as a serial connector, parallel connector, or expansion slot) and allows the processor to communicate with that device.

IrDA — Infrared Data Association — The organization that creates international standards for infrared communications.

IRQ — interrupt request — An electronic pathway assigned to a specific device so that the device can communicate with the processor. Each device connection must be assigned an IRQ. Although two devices can share the same IRQ assignment, you cannot operate both devices simultaneously.

ISP — Internet service provider — A company that allows you to access its host server to connect directly to the Internet, send and receive e-mail, and access websites. The ISP typically provides you with a software package, user name, and access phone numbers for a fee.

K

Kb — kilobit — (written as Kb) A unit of data that equals 1024 bits. A measurement of the capacity of memory integrated circuits.

KB — kilobyte — A unit of data that equals 1024 bytes but is often referred to as 1000 bytes.

key combination —

A command requiring you to press multiple keys at the same time.

kHz — kilohertz — (written as kHz) A measurement of frequency that equals 1000 Hz.

L

LAN — local area network — A computer network covering a small area. A LAN usually is confined to a building or a few nearby buildings. A LAN can be connected to another LAN over any distance through telephone lines and radio waves to form a wide area network (WAN).

LCD — liquid crystal display — The technology used by portable computer and flat-panel displays.

LED — light-emitting diode — An electronic component that emits light to indicate the status of the computer.

local bus — A data bus that provides a fast throughput for devices to the processor.

LPT — line print terminal — The designation for a parallel connection to a printer or other parallel device.

M

Mb — megabit — (written as Mb) A measurement of memory chip capacity that equals 1024 Kb.

Mbps — megabits per second — (written as Mbps) One million bits per second. This measurement is typically used for transmission speeds for networks and modems.

MB — megabyte — A measurement of data storage that equals 1,048,576 bytes. 1 MB equals 1024 KB. When used to refer to hard drive storage, the term is often rounded to 1,000,000 bytes.

MB/sec — megabytes per second — One million bytes per second. This measurement is typically used for data transfer ratings.

memory — A temporary data storage area inside your computer. Because the data in memory is not permanent, it is recommended that you frequently save your files while you are working on them, and always save your files before you shut down the computer. Your computer can contain several different forms of memory, such as RAM, ROM, and video memory. Frequently, the word memory is used as a synonym for RAM.

memory address — A specific location where data is temporarily stored in RAM.

memory mapping — The process by which the computer assigns memory addresses to physical locations at start-up. Devices and software can then identify information that the processor can access.

memory module — A small circuit board containing memory chips, which connects to the system board.

MHz — megahertz — A measure of frequency that equals 1 million cycles per second. The speeds for computer processors, buses, and interfaces are often measured in MHz.

modem — A device that allows your computer to communicate with other computers over analog telephone lines. Three types of modems include: external, PC Card, and internal. You typically use your modem to connect to the Internet and exchange e-mail.

module bay — A bay that supports devices such as optical drives, a second battery, or a Dell TravelLite™ module.

monitor — The high-resolution TV-like device that displays computer output.

mouse — A pointing device that controls the movement of the cursor on your screen. Typically you roll the mouse over a hard, flat surface to move the pointer or cursor on your screen.

ms — millisecond — A measure of time that equals one thousandth of a second. Access times of storage devices are often measured in ms.

N

network adapter — A chip that provides network capabilities. A computer may include a network adapter on its system board, or it may contain a PC Card with an adapter on it. A network adapter is also referred to as a *NIC* (network interface controller).

NIC — See *network adapter*.

notification area — The section of the Windows taskbar that contains icons for providing quick access to programs and computer functions, such as the clock, volume control, and print status. Also referred to as *system tray*.

ns — nanosecond — A measure of time that equals one billionth of a second.

NVRAM — nonvolatile random access memory — A type of memory that stores data when the computer is turned off or loses its external power source. NVRAM is used for maintaining computer configuration information such as date, time, and other system setup options that you can set.

O

optical drive — A drive that uses optical technology to read or write data from CDs, DVDs, or DVD-RWs. Example of optical drives include CD drives, DVD drives, CD-RW drives, and CD-RW/DVD combo drives.

P

parallel connector — An I/O port often used to connect a parallel printer to your computer. Also referred to as an *LPT port*.

partition — A physical storage area on a hard drive that is assigned to one or more logical storage areas known as logical drives. Each partition can contain multiple logical drives.

PC Card — A removable I/O card adhering to the PCMCIA standard. Modems and network adapters are common types of PC Cards.

PCI — peripheral component interconnect — PCI is a local bus that supports 32-and 64-bit data paths, providing a high-speed data path between the processor and devices such as video, drives, and networks.

PCMCIA — Personal Computer Memory Card International Association — The organization that establishes standards for PC Cards.

PIN — personal identification number — A sequence of numerals and/or letters used to restrict unauthorized access to computer networks and other secure systems.

PIO — programmed input/output — A method of transferring data between two devices through the processor as part of the data path.

pixel — A single point on a display screen. Pixels are arranged in rows and columns to create an image. A video resolution, such as 800 x 600, is expressed as the number of pixels across by the number of pixels up and down.

Plug-and-Play — The ability of the computer to automatically configure devices. Plug and Play provides automatic installation, configuration, and compatibility with existing hardware if the BIOS, operating system, and all devices are Plug and Play compliant.

POST — power-on self-test — Diagnostics programs, loaded automatically by the BIOS, that perform basic tests on the major computer components, such as memory, hard drives, and video. If no problems are detected during POST, the computer continues the start-up.

processor —

A computer chip that interprets and executes program instructions. Sometimes the processor is referred to as the CPU (central processing unit).

program — Any software that processes data for you, including spreadsheet, word processor, database, and game packages. Programs require an operating system to run.

PS/2 — personal system/2 — A type of connector for attaching a PS/2-compatible keyboard, mouse, or keypad.

PXE — pre-boot execution environment — A WfM (Wired for Management) standard that allows networked computers that do not have an operating system to be configured and started remotely.

R

RAID — redundant array of independent disks — A method of providing data redundancy. Some common implementations of RAID include RAID 0, RAID 1, RAID 5, RAID 10, and RAID 50.

RAM — random-access memory — The primary temporary storage area for program instructions and data. Any information stored in RAM is lost when you shut down your computer.

readme file — A text file included with a software package or hardware product. Typically, readme files provide installation information and describe new product enhancements or corrections that have not yet been documented.

read-Only — Data and/or files you can view but cannot edit or delete. A file can have read-only status if:

- o It resides on a physically write-protected floppy disk, CD, or DVD.
- o It is located on a network in a directory and the system administrator has assigned rights only to specific individuals.

refresh rate — The frequency, measured in Hz, at which your screen's horizontal lines are recharged (sometimes also referred to as its *vertical frequency*). The higher the refresh rate, the less video flicker can be seen by the human eye.

resolution — The sharpness and clarity of an image produced by a printer or displayed on a monitor. The higher the resolution, the sharper the image.

RFI — radio frequency interference — Interference that is generated at typical radio frequencies, in the range of 10 kHz to 100,000 MHz. Radio frequencies are at the lower end of the electromagnetic frequency spectrum and are more likely to have interference than the higher frequency radiations, such as infrared and light.

ROM — read-only memory — Memory that stores data and programs that cannot be deleted or written to by the computer. ROM, unlike RAM, retains its contents after you shut down your computer. Some programs essential to the operation of your computer reside in ROM.

RPM — revolutions per minute — The number of rotations that occur per minute. Hard drive speed is often measured in rpm.

RTC — real time clock — Battery-powered clock on the system board that keeps the date and time after you shut down the computer.

RTCST — real-time clock reset — A jumper on the system board of some computers that can often be used for troubleshooting problems.

S

ScanDisk — A Microsoft utility that checks files, folders, and the hard disk's surface for errors. ScanDisk often runs when you restart the computer after it has

stopped responding.

SDRAM — synchronous dynamic random-access memory — A type of DRAM that is synchronized with the optimal clock speed of the processor.

serial connector — An I/O port often used to connect devices such as a handheld digital device or digital camera to your computer.

Service Tag — A bar code label on your computer that identifies your computer when you access Dell Support at support.dell.com or when you call Dell for customer service or technical support.

setup program — A program that is used to install and configure hardware and software. The **setup.exe** or **install.exe** program comes with most Windows software packages. *Setup program* differs from *system setup*.

shortcut — An icon that provides quick access to frequently used programs, files, folders, and drives. When you place a shortcut on your Windows desktop and double-click the icon, you can open its corresponding folder or file without having to find it first. Shortcut icons do not change the location of files. If you delete a shortcut, the original file is not affected. Also, you can rename a shortcut icon.

shutdown — The process of closing windows and exiting programs, exiting the operating system, and turning off your computer. You can lose data if you turn off your computer before completing a shutdown.

smart card — A card that is embedded with a processor and a memory chip. Smart cards can be used to authenticate a user on computers equipped for smart cards.

software — Anything that can be stored electronically, such as computer files or programs.

S/PDIF — Sony/Philips Digital Interface — An audio transfer file format that allows the transfer of audio from one file to another without converting it to and from an analog format, which could degrade the quality of the file.

standby mode — A power management mode that shuts down all unnecessary computer operations to save energy.

surge protectors — Prevent voltage spikes, such as those that may occur during an electrical storm, from entering the computer through the electrical outlet. Surge protectors do not protect against lightning strikes or against brownouts, which occur when the voltage drops more than 20 percent below the normal AC-line voltage level.

Network connections cannot be protected by surge protectors. Always disconnect the network cable from the network connector during electrical storms.

SVGA — super-video graphics array — A video standard for video cards and controllers. Typical SVGA resolutions are 800 x 600 and 1024 x 768.

The number of colors and resolution that a program displays depends on the capabilities of the monitor, the video controller and its drivers, and the amount of video memory installed in the computer.

S-video TV-out — A connector used to attach a TV or digital audio device to the computer.

SXGA — super-extended graphics array — A video standard for video cards and controllers that supports resolutions up to 1280 x 1024.

SXGA+ — super-extended graphics array plus — A video standard for video cards and controllers that supports resolutions up to 1400 x 1050.

system board — The main circuit board in your computer. Also known as the *motherboard*.

system setup — A utility that serves as an interface between the computer hardware and the operating system. System setup allows you to configure user-selectable options in the BIOS, such as date and time or system password. Unless you understand what effect the settings have on the computer, do not change the settings for this program.

system tray — See *notification area*.

T

TAPI — telephony application programming interface — Enables Windows programs to operate with a wide variety of telephony devices, including voice, data, fax, and video.

text editor — A program used to create and edit files that contain only text; for example, Windows Notepad uses a text editor. Text editors do not usually provide word wrap or formatting functionality (the option to underline, change fonts, and so on).

travel module — A plastic device designed to fit inside the module bay of a portable computer to reduce the weight of the computer.

U

UPS — uninterruptible power supply — A backup power source used when the electrical power falls or drops to an unacceptable voltage level. A UPS keeps a computer running for a limited amount of time when there is no electrical power. UPS systems typically provide surge suppression and may also provide voltage regulation. Small UPS systems provide battery power for a few minutes to enable you to shut down your computer.

USB — universal serial bus — A hardware interface for a low-speed device such as a USB-compatible keyboard, mouse, joystick, scanner, set of speakers, printer, broadband devices (DSL and cable modems), imaging devices, or storage devices. Devices are plugged directly in to a 4-pin socket on your computer or in to a multi-port hub that plugs in to your computer. USB devices can be connected and disconnected while the computer is turned on, and they can also be daisy-chained together.

UTP — unshielded twisted pair — Describes a type of cable used in most telephone networks and some computer networks. Pairs of unshielded wires are twisted to protect against electromagnetic interference, rather than relying on a metal sheath around each pair of wires to protect against interference.

UXGA — ultra extended graphics array — A video standard for video cards and controllers that supports resolutions up to 1600 x 1200.

V

video controller — The circuitry on a video card or on the system board (in computers with an integrated video controller) that provides the video capabilities—in combination with the monitor—for your computer.

video memory — Memory that consists of memory chips dedicated to video functions. Video memory is usually faster than system memory. The amount of video memory installed primarily influences the number of colors that a program can display.

video mode — A mode that describes how text and graphics are displayed on a monitor. Graphics-based software, such as Windows operating systems, displays in video modes that can be defined as *x* horizontal pixels by *y* vertical pixels by *z* colors. Character-based software, such as text editors, displays in video modes that can be defined as *x* columns by *y* rows of characters.

video resolution — See *resolution*.

virus — A program that is designed to inconvenience you or to destroy data stored on your computer. A virus program moves from one computer to another through an infected disk, software downloaded from the Internet, or e-mail attachments. When an infected program starts, its embedded virus also starts.

A common type of virus is a boot virus, which is stored in the boot sectors of a floppy disk. If the floppy disk is left in the drive when the computer is shut down and then turned on, the computer is infected when it reads the boot sectors of the floppy disk expecting to find the operating system. If the computer is infected, the boot virus may replicate itself onto all the floppy disks that are read or written in that computer until the virus is eradicated.

V — volt — The measurement of electric potential or electromotive force. One V appears across a resistance of 1 ohm when a current of 1 ampere flows through that resistance.

W

W — watt — The measurement of electrical power. One W is 1 ampere of current flowing at 1 volt.

WHr — watt-hour — A unit of measure commonly used to indicate the approximate capacity of a battery. For example, a 66-WHr battery can supply 66 W of power for 1 hour or 33 W for 2 hours.

wallpaper — The background pattern or picture on the Windows desktop. Change your wallpaper through the Windows Control Panel. You can also scan in your favorite picture and make it wallpaper.

write-protected — Files or media that cannot be changed. Use write-protection when you want to protect data from being changed or destroyed. To write-protect a 3.5-inch floppy disk, slide its write-protect tab to the open position.

X

XGA — extended graphics array — A video standard for video cards and controllers that supports resolutions up to 1024 x 768.

Z

ZIF — zero insertion force — A type of socket or connector that allows a computer chip to be installed or removed with no stress applied to either the chip or its socket.

Zip — A popular data compression format. Files that have been compressed with the Zip format are called Zip files and usually have a filename extension of **.zip**. A special kind of zipped file is a self-extracting file, which has a filename extension of **.exe**. You can unzip a self-extracting file by double-clicking it.

Zip drive — A high-capacity floppy drive developed by Iomega Corporation that uses 3.5-inch removable disks called Zip disks. Zip disks are slightly larger than regular floppy disks, about twice as thick, and hold up to 100 MB of data.

[Back to Contents Page](#)

[Back to Contents Page](#)

Memory

Dell™ OptiPlex™ 210L User's Guide

- [DDR2 Memory Overview](#)
- [Addressing Memory With 4-GB Configurations](#)
- [Removing Memory](#)
- [Replacing/Adding Additional Memory](#)

For information on the type of memory supported by your computer, see the "Memory" section of the specifications for your computer:

- 1 [Mini Tower Computer Specifications](#)
- 1 [Desktop Computer Specifications](#)

➔ **NOTICE:** Before you install new memory modules, download the most recent BIOS for your computer from the Dell Support website at support.dell.com.

DDR2 Memory Overview

Dual-channel DDR2 memory modules should be installed in *pairs of matched memory size*. If the DDR2 memory modules are not installed with the same amount of memory in each channel, the computer will continue to operate, but with a slight reduction in performance. See the label in the upper-right corner of the module to determine the module's capacity.



🔍 **NOTE:** Always install DDR2 memory modules in the order indicated on the system board.

The recommended memory configurations are:

- 1 A pair of matched memory modules installed in connectors DIMM1 and DIMM2
- or
- 1 A memory module installed in connector DIMM1

➔ **NOTICE:** Do not install ECC memory modules. Doing so may cause the system not to boot or affect performance.

Be sure to install a single memory module in DIMM1, the connector closer to the processor, before you install a module in the other connector.

Addressing Memory With 4-GB Configurations

This computer supports a maximum of 4 GB of memory when you use two 2-GB DIMMs. Current operating systems, such as Microsoft® Windows® XP, can only use a maximum of 4 GB of address space; however, the amount of memory available to the operating system is less than 4 GB. Certain components within the computer require address space in the 4-GB range. Any address space reserved for these components cannot be used by computer memory.

If you use a 64-bit operating system, the entire memory range is available to the operating system.

The following components require memory address space:

- 1 System ROM
- 1 APIC(s)
- 1 Integrated PCI devices, such as network connectors and SCSI controllers
- 1 PCI cards
- 1 Graphics card
- 1 PCI Express cards (if applicable)

At start-up, the BIOS identifies the components that require address space. The BIOS dynamically calculates the amount of reserved address space required. The BIOS then subtracts the reserved address space from 4 GB to determine the amount of usable space.

- 1 If the total installed computer memory is less than the usable space, all installed computer memory is available for use only by the operating system.
- 1 If the total installed computer memory is equal to or greater than the usable address space, a small portion of installed memory is available for use by the operating system.

Removing Memory

⚠ CAUTION: Before you begin any of the procedures in this section, follow the safety instructions in the *Product Information Guide*.

👉 NOTICE: If you remove your original memory modules from the computer during a memory upgrade, keep them separate from any new modules that you may have, even if you purchased the new modules from Dell. If possible, *do not* pair an original memory module with a new memory module. Otherwise, your computer may not start properly. You should install your original memory modules in pairs either in connectors DIMM1 and DIMM2 or connectors DIMM3 and DIMM4.

👉 NOTICE: Removing memory modules from DIMM2 and DIMM4 on the desktop computer requires you to remove the optical drive (see "[Drives](#)"). Failure to do so may cause damage to the memory module and the DIMM socket.

📌 NOTE: Memory purchased from Dell is covered under your computer warranty.

1. Follow the procedures in "[Before You Begin](#)."
2. Carefully press out the securing clip at each end of the memory module connector.

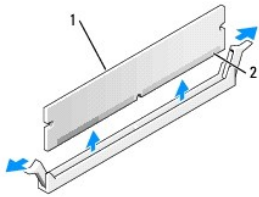

1	memory module
2	securing clip (2)

3. Remove the memory module.
-

Replacing/Adding Additional Memory

⚠ CAUTION: Before you begin any of the procedures in this section, follow the safety instructions in the *Product Information Guide*.

👉 NOTICE: To prevent static damage to components inside your computer, discharge static electricity from your body before you touch any of your computer's electronic components. You can do so by touching an unpainted metal surface on the computer chassis.

📌 NOTE: Memory purchased from Dell is covered under your computer warranty.

1. Follow the procedures in "[Before You Begin](#)."
2. Press out the securing clip at each end of the memory module connector.

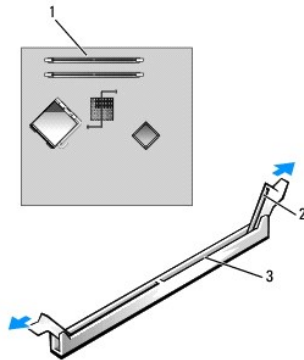

1	memory connector closer to processor
2	securing clips (2)
3	connector

3. Align the notch on the bottom of the module with the crossbar in the connector.

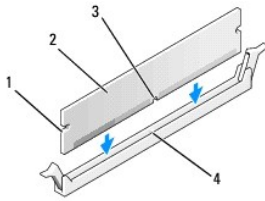

1	cutouts (2)
2	memory module
3	notch
4	crossbar

 **NOTICE:** To avoid damage to the memory module, press the module straight down into the connector while you apply equal force to each end of the module.

4. Insert the module into the connector until the module snaps into position.

If you insert the module correctly, the securing clips snap into the cutouts at each end of the module.

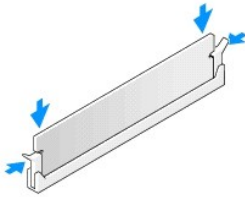

5. [Replace the computer cover.](#)

6. The computer detects that the new memory does not match the existing configuration information and generates the following message:

The amount of system memory has changed.
Strike the F1 key to continue, F2 to run the setup utility

7. Press <F2> to enter system setup and check the value for **System Memory**.

The computer should have changed the value of **System Memory** to reflect the newly installed memory. Verify the new total. If it is correct, skip to [step 9](#).

8. If the memory total is incorrect, turn off and disconnect your computer and devices from their electrical outlets. Open the computer cover and check the installed memory modules to ensure that they are seated properly in their sockets. Then repeat steps [5](#), [6](#), and [7](#).

9. When the **System Memory** total is correct, press <Esc> to exit system setup.

10. Run the [Dell Diagnostics](#) to verify that the memory modules are operating properly.

[Back to Contents Page](#)

Mini Tower Computer

Dell™ OptiPlex™ 210L User's Guide

- [About Your Mini Tower Computer](#)
- [Inside Your Computer](#)

About Your Mini Tower Computer

Front View

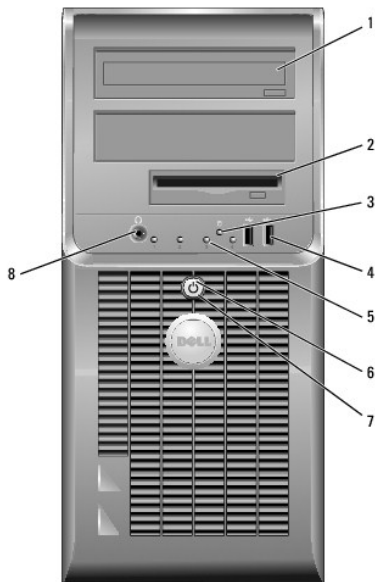

1	CD/DVD drive	Insert a CD or DVD (if applicable) into this drive.
2	floppy drive	Insert a floppy disk into this drive.
3	hard-drive activity light	This light flickers when the hard drive is in use.
4	USB 2.0 connectors (2)	Use the USB connectors on the front of the computer for devices that you connect occasionally, such as joysticks or cameras, or for bootable USB devices (see " System Setup " for more information on booting to a USB device). It is recommended that you use the USB connectors on the back of the computer for devices that typically remain connected, such as printers and keyboards.
5	diagnostic lights	Use the lights to help you troubleshoot a computer problem based on the diagnostic code. For more information, see " Diagnostic Lights ."
6	power button	Press this button to turn on the computer. NOTICE: To avoid losing data, do not turn off the computer by pressing the power button for 6 seconds or longer. Instead, perform an operating system shutdown. NOTICE: If your operating system has ACPI enabled, when you press the power button the computer will perform an operating system shutdown.
7	power light	The power light illuminates and blinks or remains solid to indicate different operating states: <ul style="list-style-type: none"> 1 No light — The computer is turned off. 1 Steady green — The computer is in a normal operating state. 1 Blinking green — The computer is in a power-saving mode. 1 Blinking or solid amber — See "Power Problems."

		<p>To exit from a power-saving mode, press the power button or use the keyboard or the mouse if it is configured as a wake device in the Windows Device Manager. For more information about sleep modes and exiting from a power-saving mode, see "Power Management."</p> <p>See "System Lights" for a description of light codes that can help you troubleshoot problems with your computer.</p>
8	headphone connector	Use the headphone connector to attach headphones and most kinds of speakers.

Back View

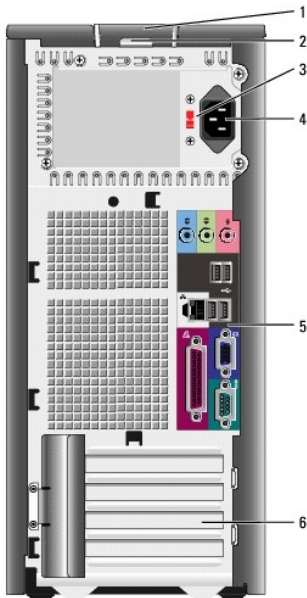

1	cover release latch	This latch allows you to open the computer cover.
2	padlock ring	Insert a padlock to lock the computer cover.
3	voltage selection switch	<p>Your computer is equipped with a manual voltage-selection switch. To help avoid damaging a computer with a manual voltage-selection switch, set the switch for the voltage that most closely matches the AC power available in your location.</p> <p>NOTICE: In Japan the voltage selection switch must be set to the 115-V position.</p> <p>Also, ensure that your monitor and attached devices are electrically rated to operate with the AC power available in your location.</p>
4	power connector	Insert the power cable into this connector.
5	back-panel connectors	Plug serial, USB, and other devices into the appropriate connector.
6	card slots	Access connectors for any installed PCI and PCI Express cards.

Back-Panel Connectors

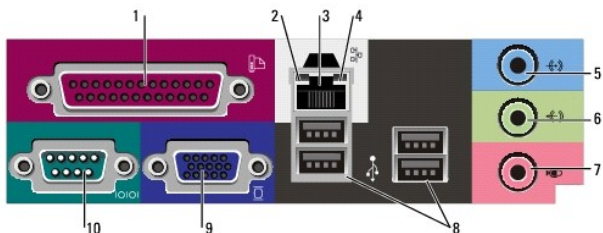

1	parallel connector	<p>Connect a parallel device, such as a printer, to the parallel connector. If you have a USB printer, plug it into a USB connector.</p> <p>NOTE: The integrated parallel connector is automatically disabled if the computer detects an installed card containing a parallel connector configured to the same address. For more information, see "System Setup Options."</p>
2	link integrity light	<ul style="list-style-type: none"> 1 Green — A good connection exists between a 10-Mbps network and the computer. 1 Orange — A good connection exists between a 100-Mbps network and the computer. 1 Yellow — A good connection exists between a 1-Gbps (or 1000-Mbps) network and the computer. 1 Off — The computer is not detecting a physical connection to the network.
3	network adapter connector	<p>To attach your computer to a network or broadband device, connect one end of a network cable to either a network jack or your network or broadband device. Connect the other end of the network cable to the network adapter connector on the back panel of your computer. A click indicates that the network cable has been securely attached.</p> <p>NOTE: Do not plug a telephone cable into the network connector.</p> <p>On computers with a network adapter card, use the connector on the card.</p> <p>It is recommended that you use Category 5 wiring and connectors for your network. If you must use Category 3 wiring, force the network speed to 10 Mbps to ensure reliable operation.</p>
4	network activity light	<p>This light flashes yellow when the computer is transmitting or receiving network data. A high volume of network traffic may make this light appear to be in a steady "on" state.</p>
5	line-in connector	<p>Use the blue line-in connector to attach a record/playback device such as a cassette player, CD player, or VCR.</p> <p>On computers with a sound card, use the connector on the card.</p>
6	line-out connector	<p>Use the green line-out connector to attach headphones and most speakers with integrated amplifiers.</p> <p>On computers with a sound card, use the connector on the card.</p>
7	microphone connector	<p>Use the pink microphone connector to attach a personal computer microphone for voice or musical input into a sound or telephony program.</p> <p>On computers with a sound card, the microphone connector is on the card.</p>
8	USB 2.0 connectors (4)	<p>Use the back USB connectors for devices that typically remain connected, such as printers and keyboards.</p>
9	video connector	<p>Plug the cable from your VGA-compatible monitor into the blue connector.</p> <p>NOTE: If you purchased an optional graphics card, this connector will be covered by a cap. Connect your monitor to the connector on the graphics card. Do not remove the cap.</p> <p>NOTE: If you are using a graphics card that supports dual monitors, use the y-cable that came with your computer.</p>
10	serial connector	<p>Connect a serial device, such as a handheld device, to the serial port. The default designation is COM1 for serial connector 1.</p> <p>For more information, see "System Setup Options."</p>

Inside Your Computer

 **CAUTION:** Before you begin any of the procedures in this section, follow the safety instructions located in the *Product Information Guide*.

 **CAUTION:** To avoid electrical shock, always unplug your computer from the electrical outlet before removing the computer cover.

 **NOTICE:** Be careful when opening the computer cover to ensure that you do not accidentally disconnect cables from the system board.

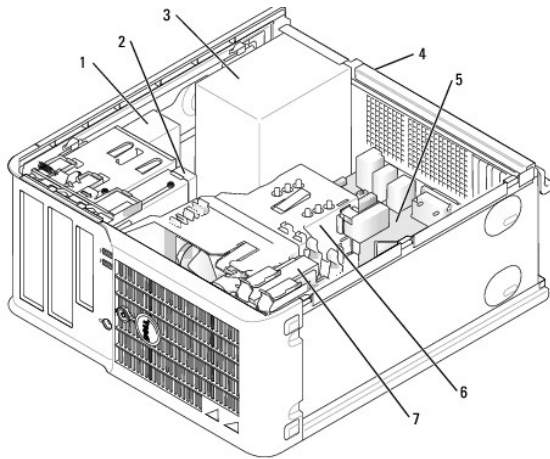

1	CD/DVD drive	5	system board
2	floppy drive	6	heat sink assembly
3	power supply	7	hard drive
4	chassis manual voltage-selection switch		



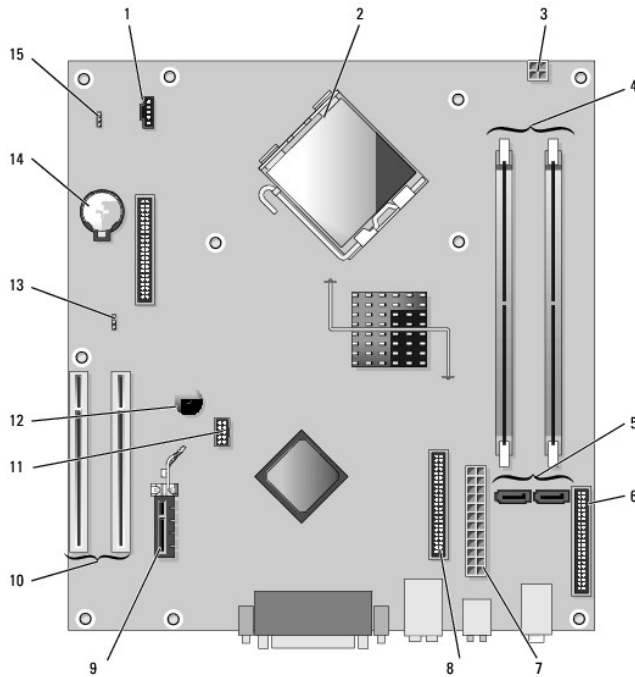



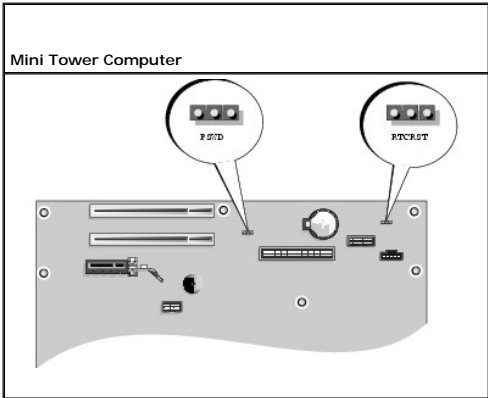

System Board Components



1	fan connector (FAN)	9	PCI Express x1 card connector
2	processor connector (CPU)	10	PCI card connector (2)
3	power connector (12VPOWER)	11	FlexBay USB connector
4	memory module connectors (DIMM_1, DIMM_2)	12	piezo buzzer
5	serial ATA drive connectors (SATA0, SATA2)	13	password jumper (PSWD)
6	front-panel connector (FNT_PANEL)	14	battery socket (BATT)
7	power connector (POWER)	15	RTC reset jumper (RTCST)
8	CD/DVD drive connector (IDE)		

Jumper Settings



Jumper	Setting	Description
PSWD 		Password features are enabled (default).
		Password features are disabled.
RTCRST 		The real-time clock has not been reset.
		The real-time clock is being reset (jumped temporarily).
 <i>jumpered</i>  <i>unjumpered</i>		

Dell™ OptiPlex™ 210L User's Guide

• [PCI and PCI Express Cards](#)

PCI and PCI Express Cards

⚠ CAUTION: Before you begin any of the procedures in this section, follow the safety instructions located in the *Product Information Guide*.

🔌 NOTICE: To prevent static damage to components inside your computer, discharge static electricity from your body before you touch any of your computer's electronic components. You can do so by touching an unpainted metal surface on the computer chassis.

Your Dell™ computer provides the following connectors for PCI and PCI Express cards.

- 1 Two [PCI card](#) slots
- 1 One [PCI Express x1 card](#) slot

📌 NOTE: Your Dell computer uses only PCI and PCI Express slots. ISA cards are not supported.

PCI Cards

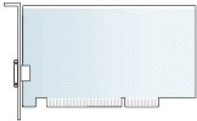

Installing a PCI Card

1. Follow the procedures in "[Before You Begin](#)."
2. Gently push the release tab on the card retention latch from the inside to pivot the latch open. The latch will remain in the open position.

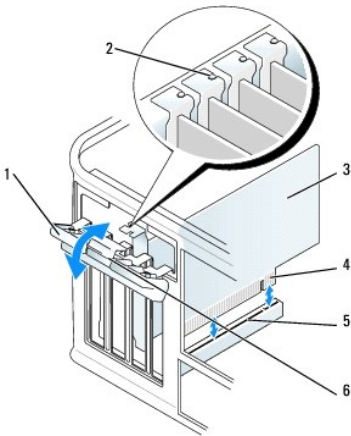

1	card retention latch	4	card-edge connector
2	alignment guide	5	card connector
3	card	6	release tab

3. Open the card retention mechanism that secures the card in place from the top:
 - a. Place your thumb on the top of the card retention mechanism and grip the bottom of the retention mechanism with your fingers.
 - b. With your free hand, gently squeeze the sides of the card retention mechanism to release it from the tab slots holding it in place.
 - c. Pivot the card retention mechanism upward to release it from the two tab slots.

4. Set the card retention mechanism aside in your work area.
5. If you are installing a new card, remove the filler bracket to create a card-slot opening. Then continue with step 5.
6. If you are replacing a card that is already installed in the computer, remove the card. If necessary, disconnect any cables connected to the card.
7. Prepare the new card for installation.

 **NOTE:** See the documentation that came with the card for information on configuring the card, making internal connections, or customizing it for your computer

 **CAUTION:** Some network adapters automatically start the computer when they are connected to a network. To guard against electrical shock, be sure to unplug your computer from its electrical outlet before installing any cards.

8. Place the card in the connector and press down firmly. Ensure that the card is fully seated in the slot.

 **NOTE:** If the card is full-length, insert the end of the card into the card-guide bracket as you lower the card toward its connector on the system board. Insert the card firmly into the card connector on the system board.

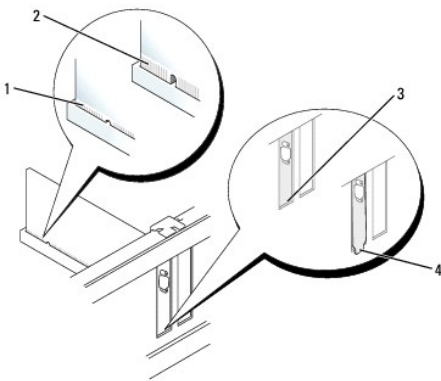

1	card fully seated
2	card not fully seated
3	bracket within slot
4	bracket caught outside of slot

9. Before you replace and lower the card retention mechanism, ensure that:
 1. The tops of all cards and filler brackets are flush with the alignment bar.
 1. The notch in the top of the card or filler bracket fits around the alignment guide.

10. Gently press down on the card retention mechanism to secure the adapter bracket in place.

11. Secure the card(s) by closing the card retention latch and snapping it into place.

 **NOTICE:** Do not route card cables over or behind the cards. Cables routed over the cards can prevent the computer cover from closing properly or cause damage to the equipment.

12. [Replace the computer cover.](#)

13. Connect any cables that should be attached to the card.

 **NOTE:** See the documentation for the card for information about the card's cable connections.

 **NOTICE:** To connect a network cable, first plug the cable into the network wall jack and then plug it into the computer.

14. If you installed a sound card:
 - a. [Enter system setup](#), select **Audio Controller**, and change the setting to **Off**.
 - b. Connect external audio devices to the sound card's connectors. Do not connect external audio devices to the microphone, speaker/headphone, or line-in connectors on the back panel of the computer.

15. If you installed an network adapter card and want to turn off the integrated network adapter:

- a. [Enter system setup](#), select **Network Controller**, and change the setting to **Off**.
 - b. Connect the network cable to the network adapter card's connectors. Do not connect the network cable to the integrated network connector on the back panel of the computer.
16. Install any drivers required for the card as described in the card documentation.

Removing a PCI Card

1. Follow the procedures in "[Before You Begin](#)."
2. Gently push the release tab on the card retention latch from the inside to pivot the latch open. The latch will remain in the open position.

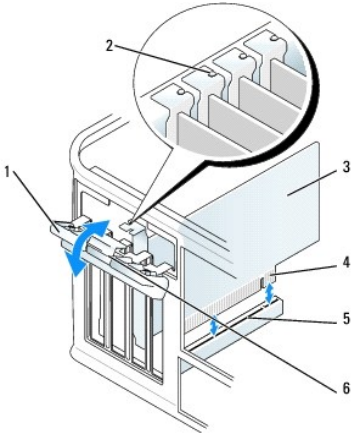

1	card retention latch	4	card-edge connector
2	alignment guide	5	card connector
3	card	6	release tab

3. Open the card retention mechanism that secures the card in place from the top:
 - a. Place your thumb on the top of the card retention mechanism and grip the bottom of the retention mechanism with your fingers.
 - b. With your free hand, gently squeeze the sides of the card retention mechanism to release it from the tab slots holding it in place.
 - c. Pivot the card retention mechanism upward to release it from the two tab slots.
4. If necessary, disconnect any cables connected to the card.
5. Grasp the card by its top corners, and ease it out of its connector.
6. If you are removing the card permanently, install a filler bracket in the empty card-slot opening.

If you need a filler bracket, [contact Dell](#).

 **NOTE:** Installing filler brackets over empty card-slot openings is necessary to maintain FCC certification of the computer. The brackets also keep dust and dirt out of your computer.

7. Before you replace and lower the card retention mechanism, ensure that:
 1. The tops of all cards and filler brackets are flush with the alignment bar.
 1. The notch in the top of the card or filler bracket fits around the alignment guide.

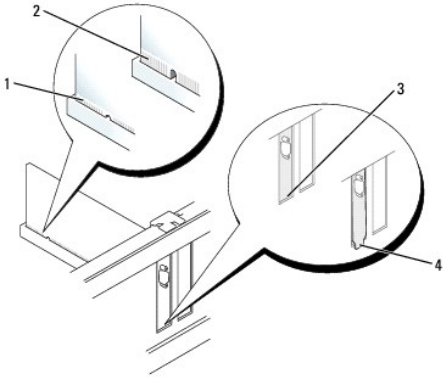

1	card fully seated
2	card not fully seated
3	bracket within slot
4	bracket caught outside of slot

8. Gently press down on the card retention mechanism to secure the adapter bracket in place.

9. Close the card retention latch by snapping it into place.

➔ **NOTICE:** To connect a network cable, first plug the cable into the network wall jack and then plug it into the computer.

10. [Replace the computer cover.](#)

11. Uninstall the card's driver. See the documentation that came with the card for instructions.

12. If you removed a sound card:

- a. [Enter system setup](#), select **Audio Controller**, and change the setting to **On**.
- b. Connect external audio devices to the audio connectors on the back panel of the computer.

13. If you removed a network-adaptor card connector:

- a. [Enter system setup](#), select **Network Controller**, and change the setting to **On**.
- b. Connect the network cable to the integrated network connector on the back panel of the computer.

PCI Express Cards

Your computer supports one PCI Express x1 card.

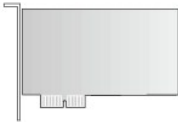

If you are installing or replacing a PCI Express card, follow the procedures in the next section. If you are removing but not replacing a card, see "[Removing a PCI Express Card](#)."

If you are replacing a card, uninstall the driver for the existing card. See the documentation that came with the card for instructions.

Installing a PCI Express Card

1. Follow the procedures in "[Before You Begin](#)."

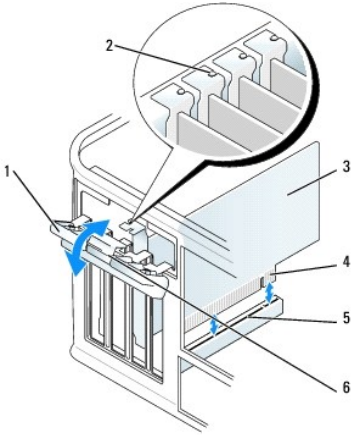

1	card retention latch	4	card-edge connector
2	alignment guide	5	card connector
3	card	6	release tab

2. Gently push the release tab on the card retention latch from the inside to pivot the latch open. The latch will remain in the open position.
3. Open the card retention mechanism that secures the card in place from the top:
 - a. Place your thumb on the top of the card retention mechanism and grip the bottom of the retention mechanism with your fingers.
 - b. With your free hand, gently squeeze the sides of the card retention mechanism to release it from the tab slots holding it in place.
 - c. Pivot the card retention mechanism upward to release it from the two tab slots.

4. If you are installing a new card, remove the filler bracket to create a card-slot opening. Then continue with [step 6](#).

5. If you are replacing a card that is already installed in the computer, remove the card.

If necessary, disconnect any cables connected to the card. If your card includes a card retention bar, remove the bar. Gently pull the securing tab, grasp the card by its top corners, and ease it out of its connector.

6. Prepare the new card for installation.

See the documentation that came with the card for information on configuring the card, making internal connections, or otherwise customizing it for your computer.

⚠ CAUTION: Some network adapters automatically start the computer when they are connected to a network. To guard against electrical shock, be sure to unplug your computer from its electrical outlet before installing any cards.

7. If you are installing the card into the x16 card connector, position the card so that the securing slot is aligned with the securing tab, and gently pull the securing tab.

8. Place the card in the connector and press down firmly. Ensure that the card is fully seated in the slot.

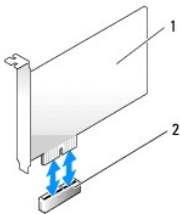

1	PCI Express x1 card
2	PCI Express x1 card slot

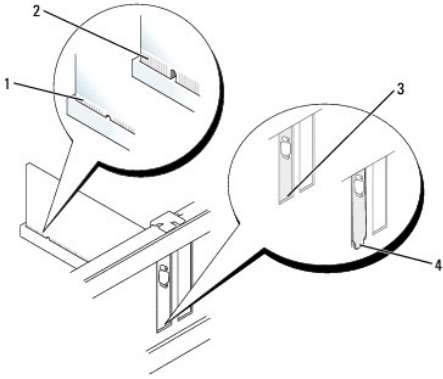

1	card fully seated
2	card not fully seated
3	bracket within slot
4	bracket caught outside of slot

9. Before you replace and lower the card retention mechanism, ensure that:

- 1. The tops of all cards and filler brackets are flush with the alignment bar.
- 1. The notch in the top of the card or filler bracket fits around the alignment guide.

10. Gently press down on the card retention mechanism to secure the adapter bracket in place.

11. Close the card retention latch and gently press until it clicks into place.

🔍 **NOTICE:** Do not route card cables over or behind the cards. Cables routed over the cards can prevent the computer cover from closing properly or cause damage to the equipment.

🔍 **NOTICE:** To connect a network cable, first plug the cable into the network wall jack and then plug it into the computer.

12. Connect any cables that should be attached to the card.

See the documentation for the card for information about the card's cable connections.

13. [Replace the computer cover.](#)

14. If you installed a sound card:

- a. [Enter system setup](#), select **Audio Controller**, and change the setting to **Off**.
- b. Connect external audio devices to the sound card's connectors. Do not connect external audio devices to the microphone, speaker/headphone, or line-in connectors on the back panel of the computer.

15. If you installed a network adapter card and want to turn off the integrated network adapter:

- a. [Enter system setup](#), select **Network Controller**, and change the setting to **Off**.
- b. Connect the network cable to the network adapter card's connectors. Do not connect the network cable to the integrated network connector on the back panel of the computer.

16. Install any drivers required for the card as described in the card documentation.

Removing a PCI Express Card

1. Follow the procedures in "[Before You Begin](#)."

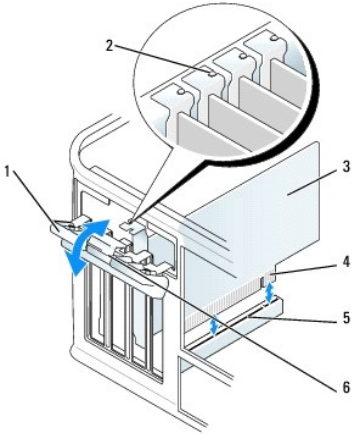

1	card retention latch	4	card-edge connector
2	alignment guide	5	card connector
3	card	6	release tab

2. Gently push the release tab on the card retention latch from the inside to pivot the latch open. Because the latch is captive, it will remain in the open position.
3. Open the card retention mechanism that secures the card in place from the top:
 - a. Place your thumb on the top of the card retention mechanism and grip the bottom of the retention mechanism with your fingers.
 - b. With your free hand, gently squeeze the sides of the card retention mechanism to release it from the tab slots holding it in place.
 - c. Pivot the card retention mechanism upward to release it from the two tab slots.

4. If you are removing the card permanently, install a filler bracket in the empty card-slot opening.

If you need a filler bracket, [contact Dell](#).

 **NOTE:** Installing filler brackets over empty card-slot openings is necessary to maintain FCC certification of the computer. The brackets also keep dust and dirt out of your computer.

5. Before you replace and lower the card retention mechanism, ensure that:
 - 1 The tops of all cards and filler brackets are flush with the alignment bar.
 - 1 The notch in the top of the card or filler bracket fits around the alignment guide.

6. Gently press down on the card retention mechanism to secure the adapter bracket in place.

 **NOTICE:** To connect a network cable, first plug the cable into the network wall jack and then plug it into the computer.

7. Secure the card(s) by closing the card retention latch and snapping it into place.

8. [Replace the computer cover](#).

Dell™ OptiPlex™ 210L User's Guide

● [Removing the Computer Cover](#)

Removing the Computer Cover

⚠ CAUTION: Before you begin any of the procedures in this section, follow the safety instructions located in the *Product Information Guide*.

⚠ CAUTION: To guard against electrical shock, always unplug your computer from the electrical outlet before removing the computer cover.

1. Follow the procedures in "[Before You Begin](#)."
2. Lay the computer on its side.
3. Slide the cover release latch back as you lift the cover.
4. Grip the sides of the computer cover and pivot the cover up using the hinge tabs as leverage points.
5. Remove the cover from the hinge tabs and set it aside on a soft nonabrasive surface.

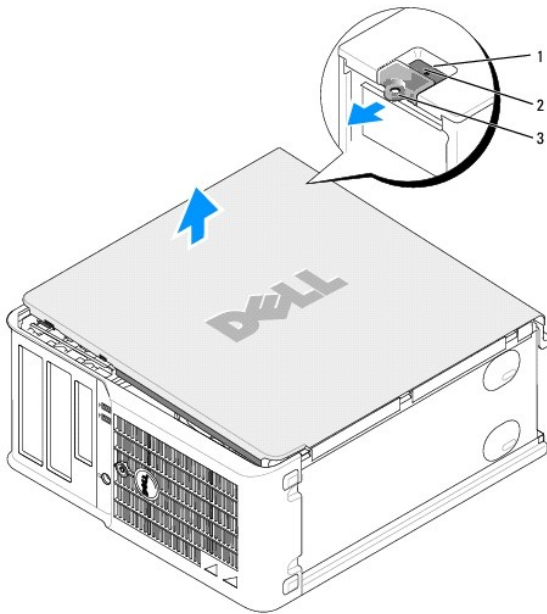

1	security cable slot
2	cover release latch
3	padlock ring

Dell™ OptiPlex™ 210L User's Guide

● [Drives](#)

Drives

Your computer supports:

- 1 Two serial ATA hard drives
- 1 Two floppy or optional Zip drives
- 1 Two CD or DVD drives

NOTE: Due to the limited number of drive bays and IDE controllers on this computer, you will not be able to connect all supported devices at once.

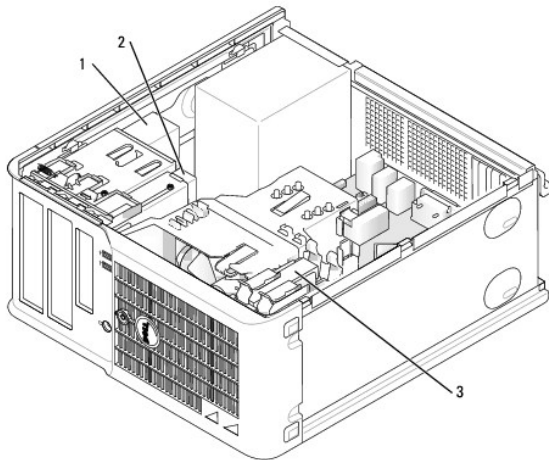

1	CD/DVD drive
2	floppy drive
3	hard drive

General Installation Guidelines

Connect CD/DVD drives to the connector labeled "IDE" on the system board. Serial ATA hard drives should be connected to the connectors labeled "SATA0" or "SATA2" on the system board.

IDE Drive Addressing

When you connect two IDE devices to a single IDE interface cable and configure them for the cable select setting, the device attached to the last connector on the interface cable is the master or boot device (drive 0), and the device attached to the middle connector on the interface cable is the slave device (drive 1). See the drive documentation in your upgrade kit for information on configuring devices for the cable select setting.

Connecting Drive Cables

When you install a drive, you connect two cables—a DC power cable and a data cable—to the back of the drive and to the system board.

Drive Interface Connectors

IDE Drive Connector	Serial ATA Connector
---------------------	----------------------

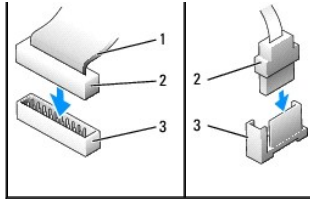

1	colored stripe on IDE cable
2	interface cable connector
3	interface connector

Most interface connectors are keyed for correct insertion; that is, a notch or a missing pin on one connector matches a tab or a filled-in hole on the other connector. Keyed connectors ensure that the pin-1 wire in the cable (indicated by the colored stripe along one edge of the IDE cable—serial ATA cables do not use a colored stripe) goes to the pin-1 end of the connector. The pin-1 end of a connector on a board or a card is usually indicated by a silk-screened "1" printed directly on the board or card.

NOTICE: When you connect an IDE interface cable, do not place the colored stripe away from pin 1 of the connector. Reversing the cable prevents the drive from operating and could damage the controller, the drive, or both.

Power Cable Connectors

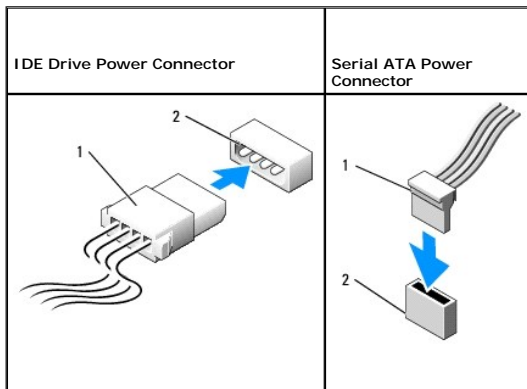

1	power cable
2	power input connector

Connecting and Disconnecting Drive Cables

When removing an IDE drive data cable, grasp the colored pull-tab and pull until the connector detaches.

When connecting and disconnecting a serial ATA data cable, hold the cable by the black connector at each end.

Like IDE connectors, the serial ATA interface connectors are keyed for correct insertion; that is, a notch or a missing pin on one connector matches a tab or a filled-in hole on the other connector.

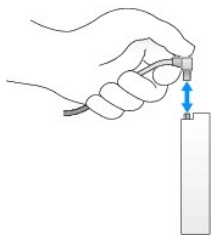

Hard Drive

CAUTION: Before you begin any of the procedures in this section, follow the safety instructions in the *Product Information Guide*.

⚠ CAUTION: To guard against electrical shock, always unplug your computer from the electrical outlet before removing the computer cover.

🛑 NOTICE: To avoid damage to the drive, do not set it on a hard surface. Instead, set the drive on a surface, such as a foam pad, that will sufficiently cushion it.

Removing a Hard Drive

1. If you are replacing a hard drive that contains data you want to keep, back up your files before you begin this procedure.
2. Check the documentation for the drive to verify that it is configured for your computer.
3. Follow the procedures in "[Before You Begin](#)."
4. Disconnect the power and hard-drive cables from the drive. Disconnect the hard-drive cable from the system board.

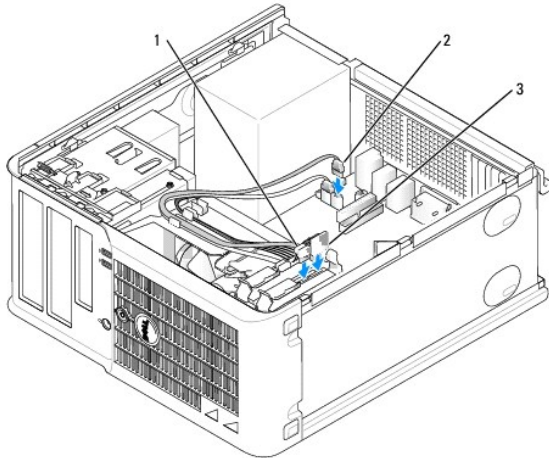

1	hard-drive cable
2	hard-drive cable on system board
3	power cable

5. Press in on the blue release tabs on each side of the drive and slide the drive up and out of the computer.

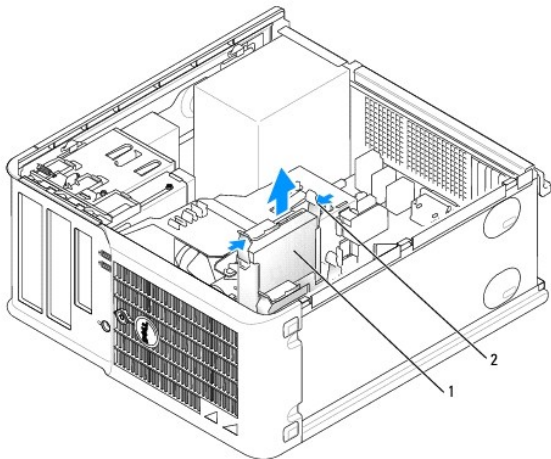

1	hard drive
2	release tabs (2)

Installing a Hard Drive

1. Unpack the replacement hard drive, and prepare it for installation.
2. Check the documentation for the drive to verify that it is configured for your computer.

 **NOTE:** If your replacement hard drive does not have the plastic hard-drive bracket attached, remove the bracket from the existing drive by unsnapping it from the drive. Snap the bracket onto the new drive.

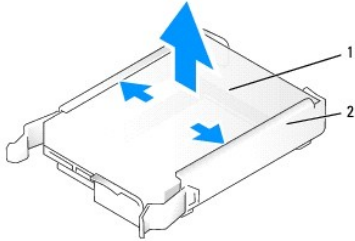

1	hard drive
2	hard-drive bracket

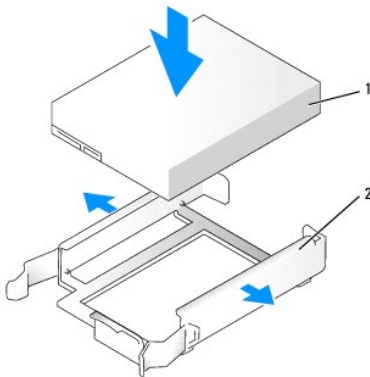

1	hard drive
2	hard-drive bracket

3. Gently slide the hard drive into the hard-drive bracket until it clicks into place.

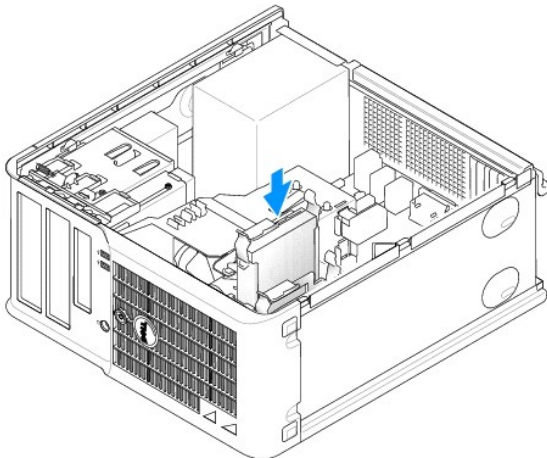

4. Gently slide the hard drive into the drive bay until it clicks into place.
5. Connect the power and hard-drive cables to the drive. Connect the hard-drive cable to the connector on the system board.
6. Check all connectors to be certain that they are properly cabled and firmly seated.

7. [Replace the computer cover.](#)
8. If the drive you just installed is the primary drive, insert a bootable medium into your boot drive. See the documentation that came with the drive for instructions on installing any software required for drive operation.
9. [Enter system setup](#) and update the appropriate **Primary Drive** option (**0** or **1**).
10. Exit system setup, and reboot the computer.
11. Partition and logically format your drive before you proceed to the next step.
See the documentation for your operating system for instructions.
12. Test the hard drive by running the [Dell Diagnostics](#).
13. If the drive you just installed is the primary drive, install your operating system on the hard drive.

Adding a Second Hard Drive

⚠ CAUTION: Before you begin any of the procedures in this section, follow the safety instructions in the *Product Information Guide*.

⚠ CAUTION: To guard against electrical shock, always unplug your computer from the electrical outlet before removing the computer cover.

🔄 NOTICE: To avoid damage to the drive, do not set it on a hard surface. Instead, set the drive on a surface, such as a foam pad, that will sufficiently cushion it.

🔄 NOTICE: If you are replacing a hard drive that contains data you want to keep, back up your files before you begin this procedure.

1. Check the documentation for the drive to verify that it is configured for your computer.
2. Follow the procedures in "[Before You Begin](#)."
3. Remove the plastic hard-drive bracket from the inside of the hard-drive bay by squeezing the release tabs and gently pulling the bracket up and out of the bay.
4. Gently spread the sides of the drive bracket and slide the hard drive into the bracket until the drive clicks into place.

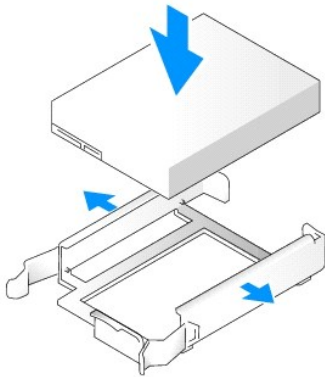

5. Move the first hard drive from the upper bay to the lower bay:
 - a. Disconnect the power and the hard-drive cables from the back of the first hard drive.
 - b. Press in on the blue release tabs on each side of the drive and slide the first hard drive up and out of the upper bay.
 - c. Gently slide the first hard drive into the lower bay until it clicks into place.
6. Gently slide the new hard drive into the upper bay until it clicks into place.
7. Connect the power cable to the drives.

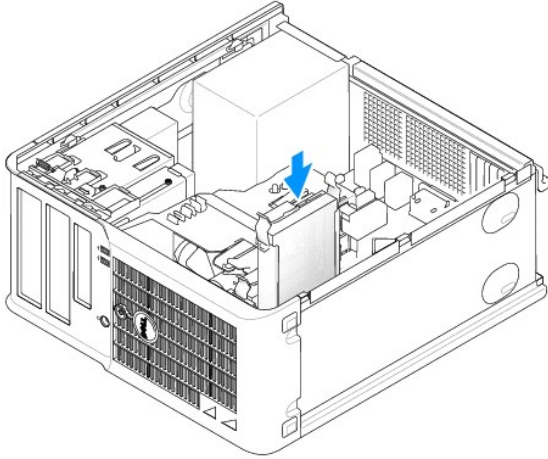

8. Attach the serial ATA connector removed in [step 5](#) to the first hard drive.
9. Locate an unused serial ATA connector on the system board and attach a drive cable to this connector and to the second hard drive.

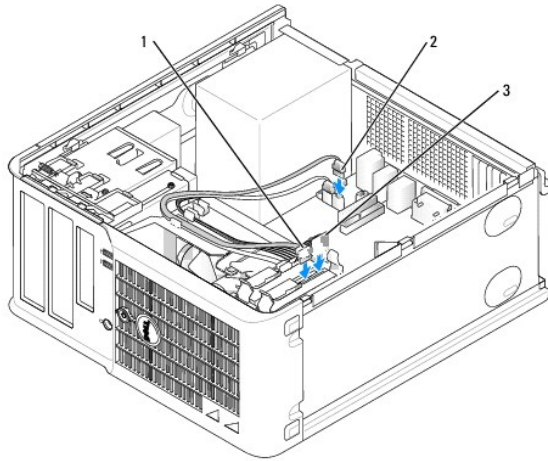

1	hard-drive cable
2	hard-drive cable on system board
3	power cable

10. [Replace the computer cover.](#)

Drive-Panel Inserts

If you are installing a new floppy or CD/DVD drive instead of replacing a drive, remove the drive-panel inserts.

1. Follow the procedures in "[Before You Begin.](#)"
2. Remove the drive panel by sliding the drive release latch downward to open the panel. Then remove it from the hinges.

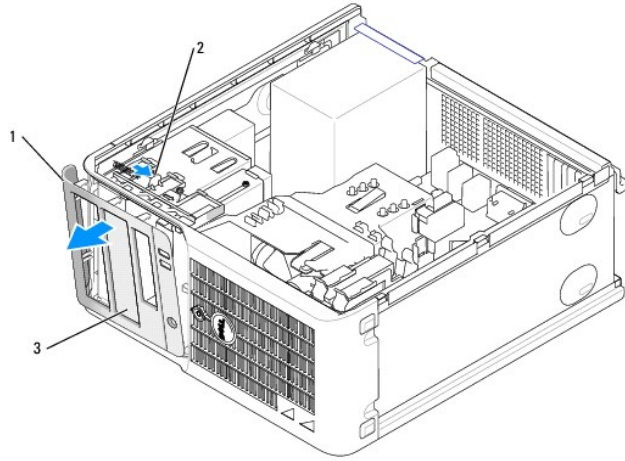

1	drive panel
2	release tab
3	drive-panel insert

3. Select the drive-panel insert in front of the drive bay that you want to use.
4. Gently press the release tab of the insert to remove it from the drive panel.

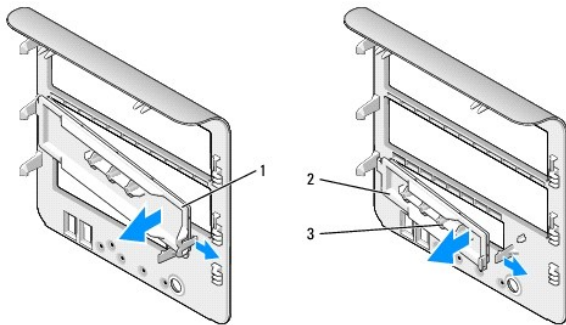

1	CD/DVD-drive panel insert
2	floppy-drive panel insert
3	holder for shoulder screws

5. Reattach the drive panel to the front of the computer.
The drive panel only fits one way.

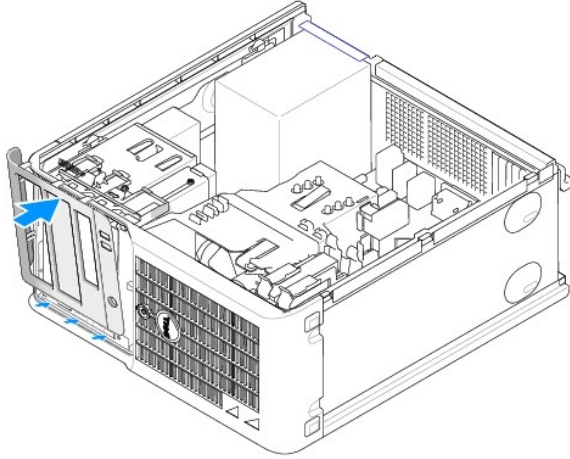

Floppy Drive

⚠ CAUTION: Before you begin any of the procedures in this section, follow the safety instructions located in the *Product Information Guide*.

⚠ CAUTION: To guard against electrical shock, always unplug your computer from the electrical outlet before removing the computer cover.

Removing the Floppy Drive

1. Follow the procedures in "[Before You Begin](#)."
2. Remove the drive panel by sliding the drive release latch downward to open the panel, and then remove it from the hinges.
3. Disconnect the power and floppy-drive cables from the back of the floppy drive.
4. Remove the floppy drive by sliding and holding the drive release latch downward. Then slide the drive out of the computer.

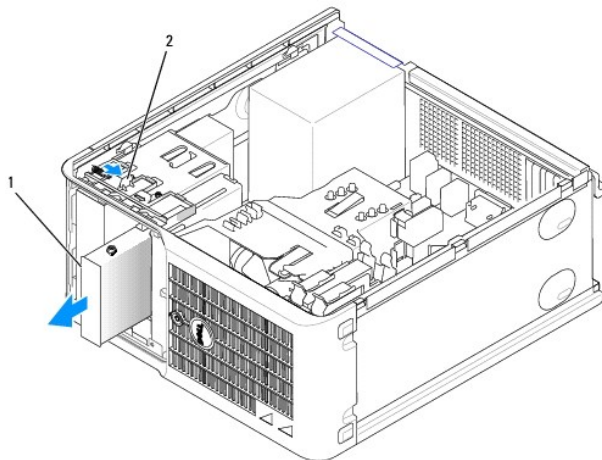

1	floppy drive
2	drive release latch

Installing the Floppy Drive

1. If you are replacing a floppy drive, remove the shoulder screws from the existing drive and attach the screws to the replacement drive.

-
2. If you are installing a new floppy drive, remove the drive-panel insert for your new drive, remove the shoulder screws from the inside of the drive-panel insert and attach the screws to the new drive.

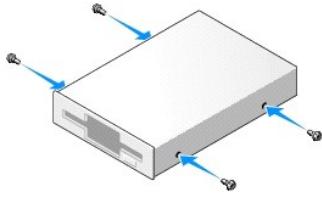

-
-
3. Align the shoulder screws on the floppy drive with the shoulder screw slots, and gently slide the drive into the bay until it clicks into place.

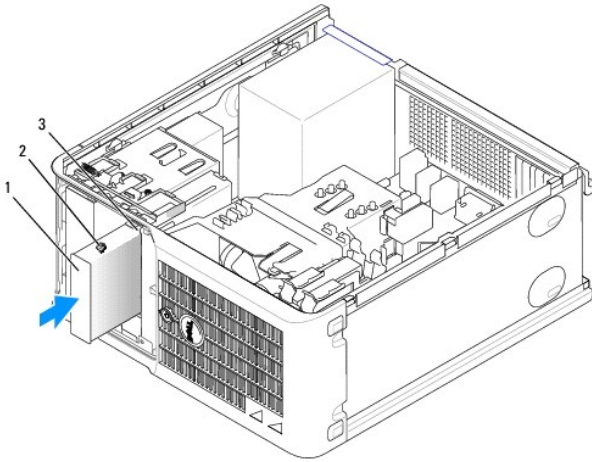

1	floppy drive
2	shoulder screws (4)
3	shoulder screw slots (2)

-
-
-
4. Attach the power and floppy-drive cables to the floppy drive.

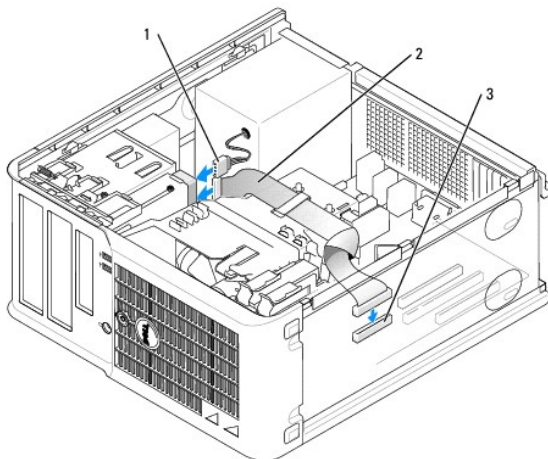

1	power cable
2	floppy-drive cable
3	floppy-drive connector (DSKT)

-
-
-
-
5. [Replace the computer cover.](#)
6. [Enter system setup](#) and use the **Diskette Drive** option to enable your new floppy drive.

7. Verify that your computer works correctly by running the [Dell Diagnostics](#).

CD/DVD Drive

⚠ CAUTION: Before you begin any of the procedures in this section, follow the safety instructions located in the *Product Information Guide*.

⚠ CAUTION: To guard against electrical shock, always unplug your computer from the electrical outlet before replacing the cover.

Removing a CD/DVD Drive

1. Follow the procedures in "[Before You Begin](#)."
2. Disconnect the power and CD/DVD drive cables from the back of the drive.
3. Remove the CD/DVD drive by sliding and holding the drive release latch downward. Then slide the drive out of the computer.

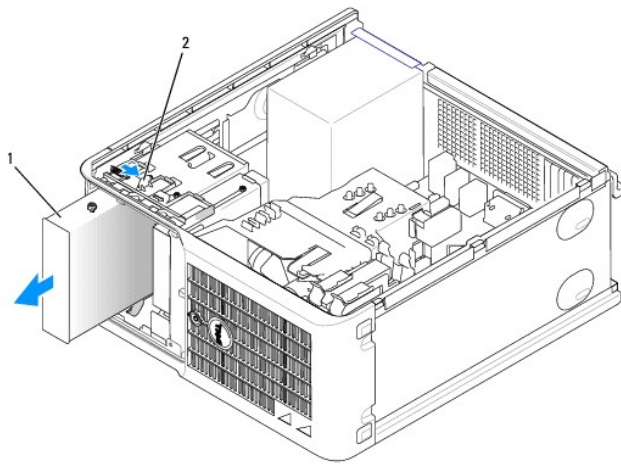

1	CD/DVD drive
2	drive release latch

Installing a CD/DVD Drive

1. Follow the procedures in "[Before You Begin](#)."
2. If you are replacing a CD/DVD drive, remove the shoulder screws from the existing drive and attach the screws to the replacement drive.
3. If you are installing a new CD/DVD drive, remove the drive-panel insert for your new drive, remove the shoulder screws from the inside of the drive-panel insert, and attach the screws to the new drive.

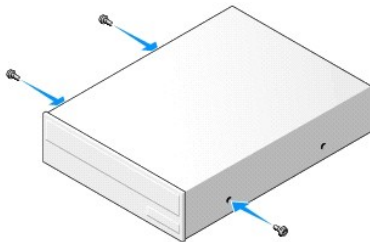

4. Check the documentation that accompanied the drive to verify that the drive is configured for your computer. If you are installing an IDE drive, configure the drive for the cable select setting by using the documentation that came with the drive.
5. Align the shoulder screws on the CD/DVD drive with the shoulder screw slots, and slide the drive into the bay until it clicks into place.

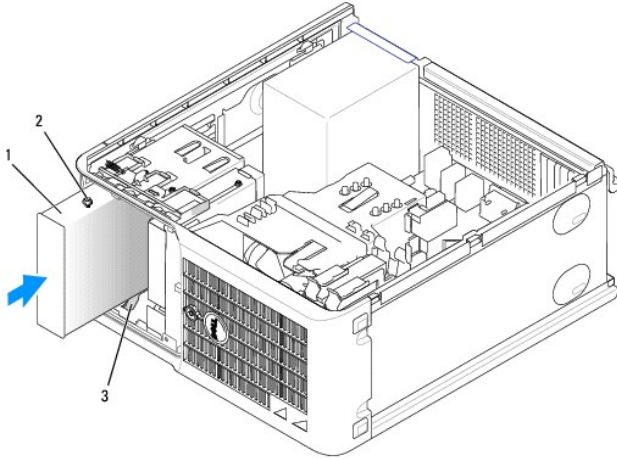

1	CD/DVD drive
2	shoulder screws (3)
3	shoulder screw slots (2)

6. Connect the power and CD/DVD drive cables to the drive and to the system board.

NOTE: The CD/DVD drive cable may be a SATA cable and appear differently than the image below. For information on SATA cable connectors, see ["General Installation Guidelines."](#)

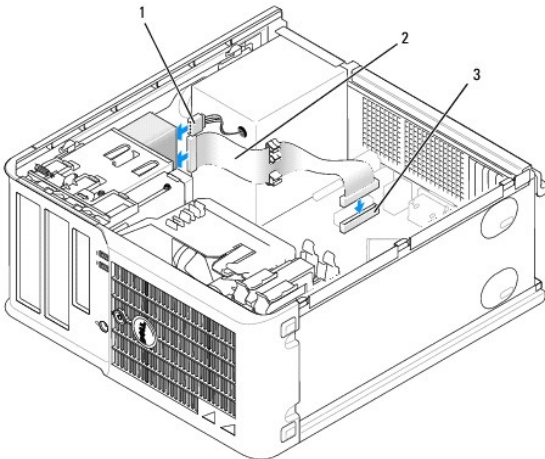

1	power cable
2	CD/DVD drive cable
3	CD/DVD drive connector (IDE)

7. Check all cable connections, and fold cables out of the way to provide airflow for the fan and cooling vents.

8. [Replace the computer cover.](#)

9. Update your configuration information in [system setup](#) by setting the appropriate **Drive** option (**0** or **1**) under **Drives**.

10. Verify that your computer works correctly by running the [Dell Diagnostics](#).

Dell™ OptiPlex™ 210L User's Guide

Mini Tower Computer



[Finding Information](#)

[Before You Begin](#)

[Recommended Tools](#)

[Turning Off Your Computer](#)

[Before Working Inside Your Computer](#)

[Mini Tower Computer](#)

[About Your Mini Tower Computer](#)

[Inside Your Computer](#)

[Mini Tower Computer Specifications](#)

[Removing the Computer Cover](#)

[I/O Panel](#)

[Drives](#)

[PCI and PCI Express Cards](#)

[Power Supply](#)

[Processor](#)

[Advanced Features](#)

[LegacySelect Technology Control](#)

[Manageability](#)

[Security](#)

[Password Protection](#)

[System Setup](#)

[Booting to a USB Device](#)

[Clearing Forgotten Passwords](#)

[Clearing CMOS Settings](#)

[Hyper-Threading](#)

[Power Management](#)

[Battery](#)

[Replacing the Battery](#)

[Replacing the System Board](#)

[Memory](#)

[DDR2 Memory Overview](#)

[Addressing Memory With 4-GB Configurations](#)

[Removing Memory](#)

[Replacing/Adding Additional Memory](#)

[Replacing the Computer Cover](#)

[Cleaning Your Computer](#)

[Reinstalling Drivers and the Operating System](#)

[Drivers](#)

[Using Microsoft® Windows® XP System Restore](#)

[Reinstalling Microsoft Windows XP](#)

[Solving Problems](#)

[Battery Problems](#)

[Drive Problems](#)

[Keyboard Problems](#)

[Lockups and Software Problems](#)

[Memory Problems](#)

[Mouse Problems](#)

[Network Problems](#)

[Power Problems](#)

[Printer Problems](#)

[Restoring Default Settings](#)

[Serial or Parallel Device Problems](#)

[Sound and Speaker Problems](#)

[Video and Monitor Problems](#)

[Microsoft® Windows® XP Features](#)

[Transferring Information to a New Computer](#)

[User Accounts and Fast User Switching](#)

[Setting Up a Home and Office Network](#)

[Glossary](#)

[Troubleshooting Tools and Utilities](#)

[Dell Diagnostics](#)

[System Lights](#)

[Diagnostic Lights](#)

[Beep Codes](#)

[Error Messages](#)

[Resolving Software and Hardware Incompatibilities](#)

[Getting Help](#)

[Technical Assistance](#)

[Problems With Your Order](#)

[Product Information](#)

[Returning Items for Warranty Repair or Credit](#)

[Before You Call](#)

[Contacting Dell](#)

[Warranty](#)

[FCC Notices \(U.S. Only\)](#)

Notes, Notices, and Cautions

 **NOTE:** A NOTE indicates important information that helps you make better use of your computer.

 **NOTICE:** A NOTICE indicates either potential damage to hardware or loss of data and tells you how to avoid the problem.

 **CAUTION:** A CAUTION indicates a potential for property damage, personal injury, or death.

Abbreviations and Acronyms

For a complete list of abbreviations and acronyms, see the [Glossary](#).

If you purchased a Dell™ n Series computer, any references in this document to Microsoft® Windows® operating systems are not applicable.

**Information in this document is subject to change without notice.
© 2006 Dell Inc. All rights reserved.**

Reproduction in any manner whatsoever without the written permission of Dell Inc. is strictly forbidden.

Trademarks used in this text: *Dell*, the *DELL* logo, *OptiPlex*, *Inspiron*, *Dimension*, *Latitude*, *Dell Precision*, *DellNet*, *Travellite*, *Dell OpenManage*, *PowerVault*, *Axim*, *PowerEdge*, *PowerConnect*, and *PowerApp* are trademarks of Dell Inc.; *Intel*, *Pentium*, and *Celeron* are registered trademarks of Intel Corporation; *Microsoft*, *MS-DOS*, and *Windows* are registered trademarks of Microsoft Corporation; *IBM* is a registered trademark of International Business Machines Corporation; *Bluetooth* is a trademark owned by Bluetooth SIG, Inc. and is used by Dell Inc. under license. *ENERGY STAR* is a registered trademark of the U.S. Environmental Protection Agency. As an ENERGY STAR partner, Dell Inc. has determined that this product meets the ENERGY STAR guidelines for energy efficiency.

Other trademarks and trade names may be used in this document to refer to either the entities claiming the marks and names or their products. Dell Inc. disclaims any proprietary interest in trademarks and Trade names other than its own.

Models: DCTR and DCNE

July 2006 P/N GD045 Rev. A02

I/O Panel

Removing the I/O Panel

⚠ CAUTION: Before you begin any of the procedures in this section, follow the safety instructions located in the *Product Information Guide*.

⚠ CAUTION: To guard against electrical shock, always unplug your computer from the electrical outlet before removing the cover.

🔧 NOTE: Note the routing of all cables as you remove them so that you can re-route them correctly when installing the new I/O panel.

1. Follow the procedures in ["Before You Begin."](#)

👉 NOTICE: When sliding the I/O panel out of the computer, be extremely careful. Carelessness may result in damage to the cable connectors and the cable routing clips.

2. Remove the screw that secures the I/O panel. Press on the release button and pull on the loop to slide the card away from the computer.
3. Disconnect all of the cables from the I/O panel, and remove the panel from the computer.

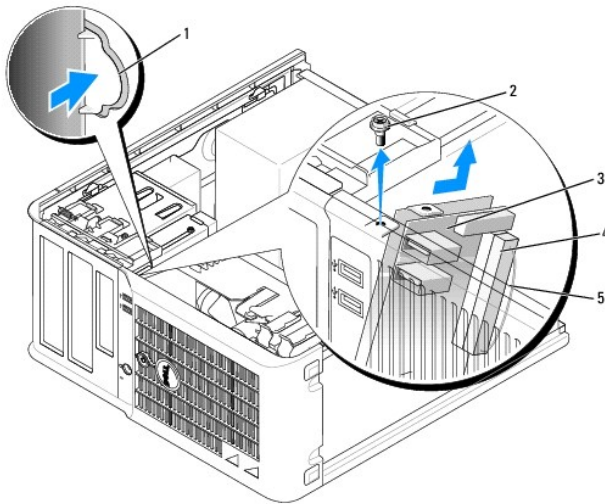

1	I/O panel release button
2	securing screw
3	I/O panel
4	I/O cable connector
5	I/O cable connector pull-loop

Replacing the I/O Panel

1. To replace the I/O panel, follow the removal procedure in the reverse order.

🔧 NOTE: Use the guides on the I/O panel bracket to help position the I/O panel in place, and use the notch on the I/O panel bracket to help seat the panel.

[Back to Contents Page](#)

Dell™ OptiPlex™ 210L User's Guide

Processor

Processor

⚠ CAUTION: Before you begin any of the procedures in this section, follow the safety instructions located in the *Product Information Guide*.

🔧 NOTICE: To prevent static damage to components inside your computer, discharge static electricity from your body before you touch any of your computer's electronic components. You can do so by touching an unpainted metal surface on the computer chassis.

Removing the Processor

1. Follow the procedures in "[Before You Begin](#)."
2. Loosen the captive screw on each side of the heat sink assembly.

⚠ CAUTION: Despite having a plastic shield, the heat sink assembly may be very hot during normal operation. Be sure that it has had sufficient time to cool before you touch it.

3. Rotate the heat sink assembly upward, and remove it from the computer.

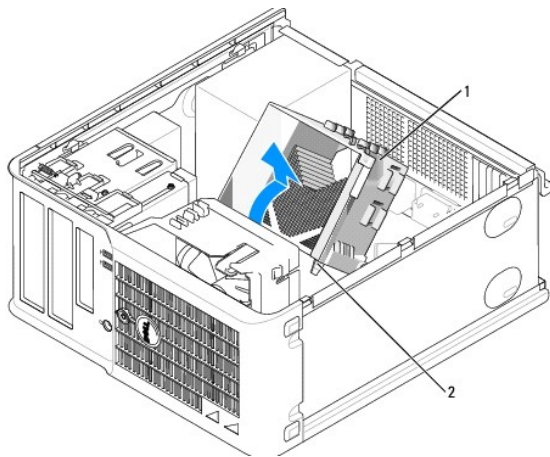

1	heat sink assembly
2	captive screw housings (2)

🔧 NOTICE: If you are installing a processor upgrade kit from Dell, remove the heat sink assembly from the shroud and discard the original heat sink. If you are *not* installing a processor upgrade kit from Dell, reuse the original heat sink when you install your new processor.

4. Open the processor cover by sliding the release lever from under the center cover latch on the socket. Then, pull the lever back to release the processor.

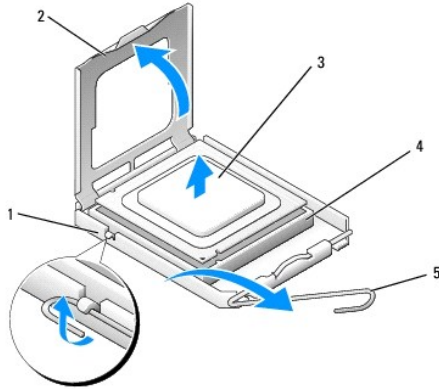

1	center cover latch
2	processor cover
3	processor
4	socket
5	release lever

➔ **NOTICE:** When replacing the processor, do not touch any of the pins inside the socket or allow any objects to fall on the pins in the socket.

5. Gently remove the processor from the socket.

Leave the release lever extended in the release position so that the socket is ready for the new processor.

Installing the Processor

➔ **NOTICE:** Ground yourself by touching an unpainted metal surface on the back of the computer.

➔ **NOTICE:** When replacing the processor, do not touch any of the pins inside the socket or allow any objects to fall on the pins in the socket.

1. Follow the procedures in "[Before You Begin.](#)"

2. Unpack the new processor, being careful not to touch the underside of the processor.

📌 **NOTE:** You must position the processor correctly in the socket to avoid permanent damage to the processor and the computer when you turn on the computer.

3. If the release lever on the socket is not fully extended, move it to that position.

4. Orient the front and rear alignment-notches on the processor with the front and rear alignment-notches on the socket.

5. Align the pin-1 corners of the processor and socket.

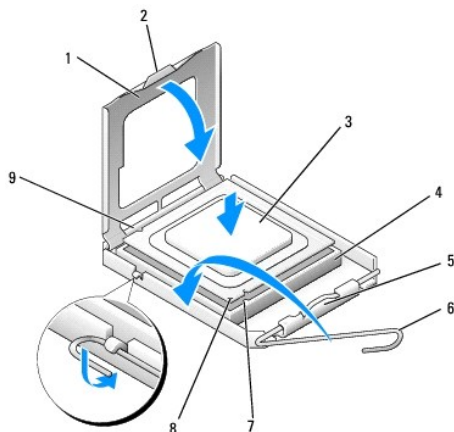

1	processor cover	6	release lever
2	tab	7	front alignment-notch
3	processor	8	socket and processor pin-1 indicator
4	processor socket	9	rear alignment-notch
5	center cover latch		

➔ **NOTICE:** To avoid damage, ensure that the processor aligns properly with the socket, and do not use excessive force when you install the processor.

6. Set the processor lightly in the socket and ensure that the processor is positioned correctly.

7. When the processor is fully seated in the socket, close the processor cover.

Ensure that the tab on the processor cover is positioned underneath the center cover latch on the socket.

8. Pivot the socket release lever back toward the socket, and snap it into place to secure the processor.

➔ **NOTICE:** If you are *not* installing a processor upgrade kit from Dell, reuse the original heat sink assembly when you replace the processor.

If you installed a processor replacement kit from Dell, remove the original heat sink assembly from the shroud and return it with the processor to Dell in the same package in which your replacement kit was sent.

9. Install the heat sink assembly:

a. Place the heat sink assembly back onto the heat-sink assembly bracket.

b. Rotate the heat sink assembly down towards the computer base and tighten the two captive screws.

➔ **NOTICE:** Ensure that the heat sink assembly is correctly seated and secure.

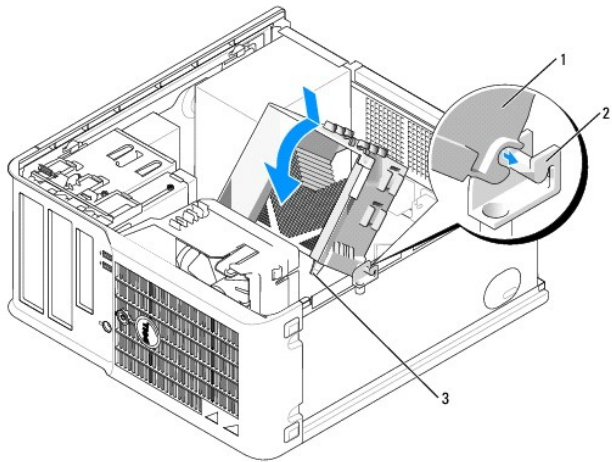

1	heat sink assembly
2	heat-sink assembly bracket
3	captive screw housing (2)

10. [Replace the computer cover.](#)

Power Supply

Replacing the Power Supply

⚠ CAUTION: Before you begin any of the procedures in this section, follow the safety instructions located in the *Product Information Guide*.

🔌 NOTICE: To prevent static damage to components inside your computer, discharge static electricity from your body before you touch any of your computer's electronic components. You can do so by touching an unpainted metal surface on the computer chassis.

1. Follow the procedures in "[Before You Begin](#)."
2. Disconnect the DC power cables from the system board and the drives.

Note the routing of the DC power cables underneath the tabs in the computer chassis as you remove them from the system board and drives. You must route these cables properly when you replace them to prevent them from being pinched or crimped.

3. Remove the four screws that attach the power supply to the back of the computer chassis.
4. Press the release button located on the floor of the computer chassis.

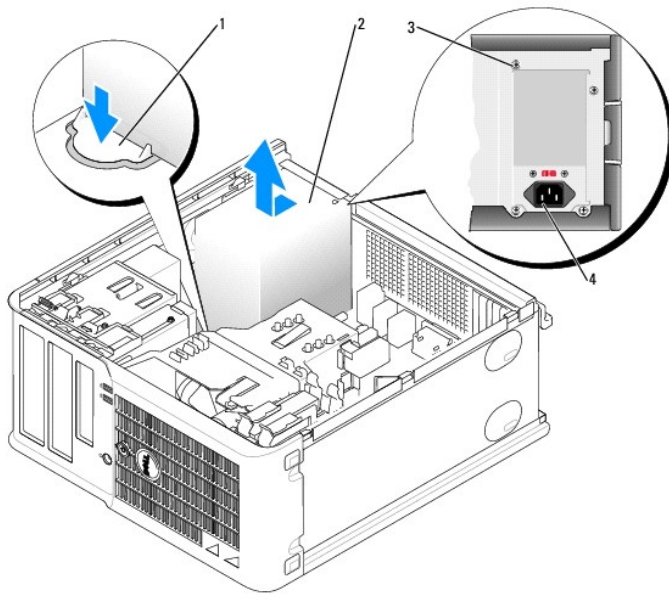

1	release button
2	power supply
3	screws (4)
4	AC power connector

5. Slide the power supply toward the front of the computer by approximately 1 inch.
6. Lift the power supply up and out of the computer.
7. Slide the replacement power supply into place.
8. Replace the screws that secure the power supply to the back of the computer chassis.

9. Reconnect the DC power cables to the power supply.
10. Connect the AC power cable to the AC power connector.
11. [Replace the computer cover.](#)

DC Power Connectors

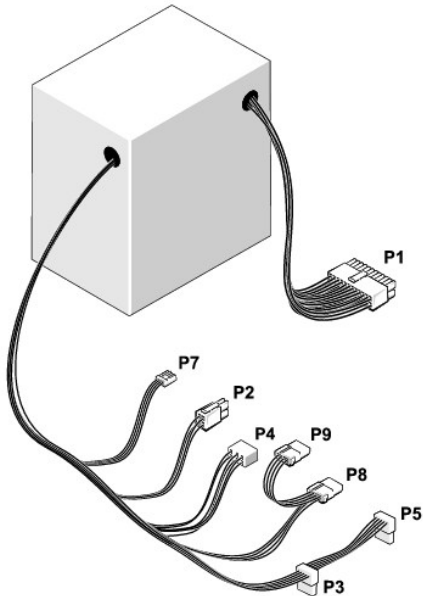

DC Power Connector P1

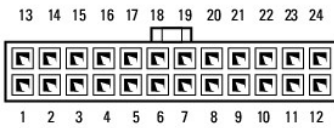

Pin Number	Signal name	18-AWG Wire
1	+3.3 VDC	Orange
2	+3.3 VDC	Orange
3	GND	Black
4	VCC (+5 V)	Red
5	GND	Black
6	VCC (+5 V)	Red
7	GND	Black
8	PS_PWRGOOD	Gray
9	P5AUX	Purple
10	V_12PO_DIG	Yellow
11	V_12PO_DIG	Yellow
12	+3.3 V	Orange
13	+3.3 V	Orange
14	-12 V*	Blue
15	GND	Black
16	PWR_PS_ON	Green
17	GND	Black
18	GND	Black

19	GND	Black
20	NC	N/C
21	VCC (+5 V)	Red
22	VCC (+5 V)	Red
23	VCC (+5 V)	Red
24	GND	Black

*Use 22-AWG wire instead of 18-AWG wire.

DC Power Connector P2



Pin Number	Signal Name	18-AWG Wire
1	COM	Black
2	COM	Black
3	+12 VDC	Yellow
4	+12 VDC	Yellow

DC Power Connectors P3 and P5



Pin Number	Signal name	18-AWG Wire
1	+3.3 VDC	Orange
2	COM	Black
3	+5 VDC	Red
4	COM	Black
5	+12 VDC	Yellow

DC Power Connector P4

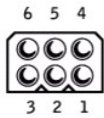

Pin Number	Signal name	18-AWG Wire
1		N/C
2	COM	Black
3	COM	Black
4	+ 3.3 VDC	Orange
5	+5 VDC	Red
6	+12 VDC	Yellow

DC Power Connector P7

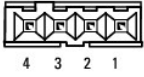

Pin Number	Signal Name	22-AWG Wire
1	+5 VCD	Red
2	COM	Black
3	COM	Black
4	+12 VDC	Yellow

DC Power Connectors P8 and P9

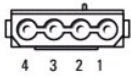

Pin Number	Signal name	18-AWG Wire
1	+12 VDC	Yellow
2	COM	Black
3	COM	Black
4	+5 VDC	Red

[Back to Contents Page](#)

Dell™ OptiPlex™ 210L User's Guide

● [Mini Tower Computer Specifications](#)

Mini Tower Computer Specifications

Microprocessor	
Microprocessor type	Intel® Pentium® or Celeron® processor
Level 1 (L1) cache	32 KB
Level 2 (L2) cache	512-KB, 1-MB, or 2-MB pipelined-burst, eight-way set associative, write-back SRAM

Memory	
Type	400-MHz and 533-MHz DDR2 SDRAM
Memory connectors	2
Memory modules supported	256-MB, 512-MB, 1-GB or 2-GB non-ECC
Minimum memory	dual-channel: 512 MB single-channel: 256 MB
Maximum memory	4 GB
BIOS address	F0000h

Computer Information	
Chipset	Intel® 915GV
Data bus width	64 bits
Address bus width	32 bits
DMA channels	eight
Interrupt levels	24
BIOS chip (NVRAM)	4 Mb
Memory speed	400 MHz and 533 MHz
NIC	integrated network interface capable of 10/100 communication: <ul style="list-style-type: none">1 Green — A good connection exists between a 10-Mbps network and the computer.1 Orange — A good connection exists between a 100-Mbps network and the computer.1 Off — The computer is not detecting a physical connection to the network.

Video	
Type	integrated Intel Graphic Media Accelerator 900

Audio	
Type	SigmaTel STAC9200
Stereo conversion	16-bit analog-to-digital; 20-bit digital-to-analog

Controllers	
Drives	two serial ATA controllers supporting one device each and one parallel Ultra ATA/100 IDE supporting two devices per channel with one channel

Other	
--------------	--

Expansion Bus	
Bus type	PCI 2.3 SATA 1.0a USB 2.0 PCI Express 1.0a
Bus speed	PCI: 33 MHz SATA: 1.5 Gbps and 3.0 Gbps USB: 480 Mbps PCI Express x1: 5 Gbps
Cards:	full-height cards supported
PCI:	
connectors	two
connector size	120 pins
connector data width (maximum)	32 bits
PCI Express:	
connectors	one x1
power	10 W maximum
connector size	36 pins
connector data width (maximum)	one PCI Express lane

Drives	
Externally accessible	one 3.5-inch drive two 5.25-inch drive bays
Internally accessible	two bays for 1-inch-high hard drives

Connectors	
External connectors:	
Serial	9-pin connector; 16550C-compatible
Parallel	25-hole connector (bidirectional)
Video	15-hole VGA connector
Network adapter	RJ45 connector
USB	two front-panel and four back-panel USB 2.0-compliant connectors
Audio	three back connectors for line-in, line-out, and microphone; one front-panel connector for headphones
System board connectors:	
Primary IDE drive	40-pin connector
Serial ATA	two 7-pin connectors
Floppy drive	34-pin connector
Fan	5-pin connector
PCI 2.3	120-pin connector
CD drive audio interface	4-pin connector
Front panel	40-pin connector

Key Combinations	
<Ctrl><Alt>	in Microsoft® Windows® XP, brings up the Windows Security window.; in DOS mode, restarts (reboots) the computer
<F2> or <Ctrl><Alt><Enter>	starts embedded system setup (during system start-up only)
<Ctrl><Alt>	automatically starts the computer from the network environment specified by the remote boot environment (PXE) rather than from one of the devices in the system setup Boot Sequence option (during system start-up only)
<F12> or <Ctrl><Alt><F8>	displays a boot device menu that allows the user to enter a device for a single boot (during system start-up only) as well as options to run hard-drive and system diagnostics

--	--

Controls and Lights	
Power control	push button
Power light	green light — Blinking green indicates sleep mode; solid green indicates power-on state. amber light — Blinking amber indicates a problem with an installed device; solid amber indicates an internal power problem (see "Power Problems").
Hard-drive access light	green
Link light	solid green light indicates network connection
Link integrity light (on integrated network adapter)	green light for 10-Mb operation and orange light for 100-Mb operation
Activity light (on integrated network adapter)	yellow blinking light
Diagnostic lights	four lights on the front panel (see "Diagnostic Lights")
Standby power light	AUX_PWR on the system board

Power	
DC power supply:	
Wattage	230 W
Heat dissipation	785 BTU/hr NOTE: Heat dissipation is calculated based upon the power supply wattage rating.
Voltage	manual selection power supplies — 90 to 135 V at 50/60 Hz; 180 to 265 V at 50/60 Hz
Backup battery	3-V CR2032 lithium coin cell

Physical	
Height	41.4 cm (16.3 inches)
Width	18.5 cm (7.3 inches)
Depth	43.9 cm (17.3 inches)
Weight	12.34 kg (27.2 lb)

Environmental	
Temperature:	
Operating	10° to 35°C (50° to 95°F)
Storage	-40° to 65°C (-40° to 149°F)
Relative humidity	20% to 80% (noncondensing)
Maximum vibration:	
Operating	0.25 G at 3 to 200 Hz at 0.5 octave/min
Storage	0.5 G at 3 to 200 Hz at 1 octave/min
Maximum shock:	
Operating	bottom half-sine pulse with a change in velocity of 50.8 cm/sec (20 inches/sec)
Storage	27-G faired square wave with a velocity change of 508 cm/sec (200 inches/sec)
Altitude:	
Operating	-15.2 to 3048 m (-50 to 10,000 ft)
Storage	-15.2 to 10,668 m (-50 to 35,000 ft)

[Back to Contents Page](#)

[Back to Contents Page](#)

FCC Notices (U.S. Only)

Dell™ OptiPlex™ 210L User's Guide

Electromagnetic Interference (EMI) is any signal or emission, radiated in free space or conducted along power or signal leads, that endangers the functioning of a radio navigation or other safety service or seriously degrades, obstructs, or repeatedly interrupts a licensed radio communications service. Radio communications services include but are not limited to AM/FM commercial broadcast, television, cellular services, radar, air-traffic control, pager, and Personal Communication Services (PCS). These licensed services, along with unintentional radiators such as digital devices, including computer systems, contribute to the electromagnetic environment.

Electromagnetic Compatibility (EMC) is the ability of items of electronic equipment to function properly together in the electronic environment. While this computer system has been designed and determined to be compliant with regulatory agency limits for EMI, there is no guarantee that interference will not occur in a particular installation. If this equipment does cause interference with radio communications services, which can be determined by turning the equipment off and on, you are encouraged to try to correct the interference by one or more of the following measures:

- 1 Reorient the receiving antenna.
- 1 Relocate the computer with respect to the receiver.
- 1 Move the computer away from the receiver.
- 1 Plug the computer into a different outlet so that the computer and the receiver are on different branch circuits.

If necessary, consult a Dell Technical Support representative or an experienced radio/television technician for additional suggestions.

For additional regulatory information, see the *Product Information Guide* that came with your computer.

Dell™ computer systems are designed, tested, and classified for their intended electromagnetic environment. These electromagnetic environment classifications generally refer to the following harmonized definitions:

- 1 Class A is typically for business or industrial environments.
- 1 Class B is typically for residential environments.

Information Technology Equipment (ITE), including peripherals, expansion cards, printers, input/output (I/O) devices, monitors, and so on, that are integrated into or connected to the system should match the electromagnetic environment classification of the computer system.

A Notice About Shielded Signal Cables: Use only shielded cables for connecting peripherals to any Dell device to reduce the possibility of interference with radio communications services. Using shielded cables ensures that you maintain the appropriate EMC classification for the intended environment. For parallel printers, a cable is available from Dell. If you prefer, you can order a cable from Dell on the World Wide Web at accessories.us.dell.com/sna/category.asp?category_id=4117.

Most Dell computer systems are classified for Class B environments. However, the inclusion of certain options can change the rating of some configurations to Class A. To determine the electromagnetic classification for your system or device, see the following sections specific for each regulatory agency. Each section provides country-specific EMC/EMI or product safety information.

FCC Notices (U.S. Only)

Most Dell computer systems are classified by the Federal Communications Commission (FCC) as Class B digital devices. To determine which classification applies to your computer system, examine all FCC registration labels located on the bottom, side, or back panel of your computer, on card-mounting brackets, and on the cards themselves. If any one of the labels carries a Class A rating, your entire system is considered to be a Class A digital device. If *all* labels carry an FCC Class B rating as distinguished by either an FCC ID number or the FCC logo, (FCC), your system is considered to be a Class B digital device.

Once you have determined your system's FCC classification, read the appropriate FCC notice. Note that FCC regulations provide that changes or modifications not expressly approved by Dell could void your authority to operate this equipment.

This device complies with Part 15 of the FCC Rules. Operation is subject to the following two conditions:

- 1 This device may not cause harmful interference.
- 1 This device must accept any interference received, including interference that may cause undesired operation.

Class A

This equipment has been tested and found to comply with the limits for a Class A digital device pursuant to Part 15 of the FCC Rules. These limits are designed to provide reasonable protection against harmful interference when the equipment is operated in a commercial environment. This equipment generates, uses, and can radiate radio frequency energy and, if not installed and used in accordance with the manufacturer's instruction manual, may cause interference with radio communications. Operation of this equipment in a residential area is likely to cause harmful interference, in which case you will be required to correct the interference at your own expense.

Class B

This equipment has been tested and found to comply with the limits for a Class B digital device pursuant to Part 15 of the FCC Rules. These limits are designed to provide reasonable protection against harmful interference in a residential installation. This equipment generates, uses, and can radiate radio frequency energy and, if not installed and used in accordance with the manufacturer's instruction manual, may cause interference with radio communications. However, there is no guarantee that interference will not occur in a particular installation. If this equipment does cause harmful interference to radio or television reception, which can be determined by turning the equipment off and on, you are encouraged to try to correct the interference by one or more of the following measures:

- 1 Reorient or relocate the receiving antenna.

- 1 Increase the separation between the equipment and the receiver.
- 1 Connect the equipment into an outlet on a circuit different from that to which the receiver is connected.
- 1 Consult the dealer or an experienced radio/television technician for help.

FCC Identification Information

The following information is provided on the device or devices covered in this document in compliance with FCC regulations:

- 1 Model numbers: DCTR and DCNE
- 1 Company name:

Dell Inc.
One Dell Way
Round Rock, Texas 78682 USA
512-338-4400

[Back to Contents Page](#)

Reinstalling Drivers and the Operating System

Dell™ OptiPlex™ 210L User's Guide

- [Drivers](#)
- [Using Microsoft® Windows® XP System Restore](#)
- [Reinstalling Microsoft Windows XP](#)

 **CAUTION:** Before you begin any of the procedures in this section, follow the safety instructions in the *Product Information Guide*.

 **NOTICE:** You must use Microsoft® Windows® XP Service Pack 1 or later when you reinstall the Microsoft Windows XP operating system.

 **NOTE:** If you installed a unique image on your computer or if you had to reinstall your operating system, run the DSS utility. DSS is available on your optional *Drivers and Utilities* CD (*Resource CD*) and at support.dell.com.

Drivers

What Is a Driver?

A driver is a program that controls a device such as a printer, mouse, or keyboard. All devices require a driver program.

A driver acts like a translator between the device and any other programs that use the device. Each device has its own set of specialized commands that only its driver recognizes.

Dell ships your computer to you with required drivers already installed—no further installation or configuration is needed.

 **NOTICE:** The optional *Drivers and Utilities* CD (*Resource CD*) may contain drivers for operating systems that are not on your computer. Ensure that you are installing software appropriate for your operating system.

Many drivers, such as the keyboard driver, come with your Microsoft Windows operating system. You may need to install drivers if you:

- 1 Upgrade your operating system.
- 1 Reinstall your operating system.
- 1 Connect or install a new device.

Identifying Drivers

If you experience a problem with any device, identify whether the driver is the source of your problem and, if necessary, update the driver.

1. Click the **Start** button and click **Control Panel**.
2. Under **Pick a Category**, click **Performance and Maintenance**.
3. Click **System**.
4. In the **System Properties** window, click the **Hardware** tab.
5. Click **Device Manager**.
6. Scroll down the list to see if any device has an exclamation point (a yellow circle with a [!]) on the device icon.

If an exclamation point is next to the device name, you may need to [reinstall the driver](#) or install a new driver.

Reinstalling Drivers and Utilities

 **NOTICE:** The Dell Support website at support.dell.com and your *Drivers and Utilities* CD (*Resource CD*) provide approved drivers for Dell™ computers. If you install drivers obtained from other sources, your computer might not work correctly.

 **NOTE:** The *Drivers and Utilities* CD (*Resource CD*) is optional, and as such, may not ship with certain computers.

Using Windows XP Device Driver Rollback

If a problem occurs on your computer after you install or update a driver, use Windows XP Device Driver Rollback to replace the driver with the previously installed version.

1. Click the **Start** button and click **Control Panel**.
2. Under **Pick a Category**, click **Performance and Maintenance**.
3. Click **System**.
4. In the **System Properties** window, click the **Hardware** tab.
5. Click **Device Manager**.
6. Right-click the device for which the new driver was installed and click **Properties**.
7. Click the **Drivers** tab.
8. Click **Roll Back Driver**.

If Device Driver Rollback does not resolve the problem, then use System Restore (see "[Enabling System Restore](#)") to return your computer to the operating state that existed before you installed the new driver.

Using the Optional Drivers and Utilities CD

If using Device Driver Rollback or [System Restore](#) does not resolve the problem, then reinstall the driver from the *Drivers and Utilities* CD (also known as the *Resource* CD).

 **NOTE:** The *Drivers and Utilities* CD (*Resource* CD) is optional, and as such, may not ship with all computers.

 **NOTE:** To access device drivers and user documentation, you must use the *Drivers and Utilities* CD (*Resource* CD) while your computer is running Windows.

1. Insert the *Drivers and Utilities* CD.

If this is your first time to use the *Drivers and Utilities* CD, the **Installation** window opens to inform you that the CD will begin the installation. Click **OK** and respond to the installation program prompts to complete the installation.

2. Click **Next** at the **Welcome Dell System Owner** screen.
3. Choose the appropriate selections for **System Model**, **Operating System**, **Device Type**, and **Topic**.
4. Click **My Drivers** in the **Topic** drop-down menu.

The *Drivers and Utilities* CD scans your computer's hardware and operating system and then displays a list of device drivers for your system configuration.

5. Click the appropriate driver and follow the instructions to download the driver for your computer.

To view a list of all available drivers for your computer, click **Drivers** in the **Topic** drop-down menu.

To access the help files on the *Drivers and Utilities* CD, click the question mark button or the **Help** link at the top of the screen.

Using Microsoft® Windows® XP System Restore

The Microsoft Windows XP operating system provides System Restore to allow you to return your computer to an earlier operating state (without affecting data files) if changes to the hardware, software, or other system settings have left the computer in an undesirable operating state. See the Windows Help and Support Center for information on using System Restore.

 **NOTICE:** Make regular backups of your data files. System Restore does not monitor your data files or recover them.

Creating a Restore Point

1. Click the **Start** button and click **Help and Support**.
2. Click **System Restore**.
3. Follow the instructions on the screen.

Restoring the Computer to an Earlier Operating State

 **NOTICE:** Before you restore the computer to an earlier operating state, save and close any open files and exit any open programs. Do not alter, open, or delete any files or programs until the system restoration is complete.

1. Click the **Start** button, point to **All Programs**→ **Accessories**→ **System Tools**, and then click **System Restore**.
2. Ensure that **Restore my computer to an earlier time** is selected and click **Next**.
3. Click a calendar date to which you want to restore your computer.

The **Select a Restore Point** screen provides a calendar that allows you to see and select restore points. All calendar dates with available restore points appear in boldface type.

4. Select a restore point and click **Next**.

If a calendar date has only one restore point, then that restore point is automatically selected. If two or more restore points are available, click the restore point that you prefer.

5. Click **Next**.

The **Restoration Complete** screen appears after System Restore finishes collecting data and then the computer restarts.

6. After the computer restarts, click **OK**.

To change the restore point, you can either repeat the steps using a different restore point, or you can undo the restoration.

Undoing the Last System Restore

 **NOTICE:** Before you undo the last system restore, save and close all open files and exit any open programs. Do not alter, open, or delete any files or programs until the system restoration is complete.

1. Click the **Start** button, point to **All Programs**→ **Accessories**→ **System Tools**, and then click **System Restore**.
2. Click **Undo my last restoration** and click **Next**.
3. Click **Next**.

The **System Restore** screen appears and the computer restarts.

4. After the computer restarts, click **OK**.

Enabling System Restore

If you reinstall Windows XP with less than 200 MB of free hard-disk space available, System Restore is automatically disabled. To see if System Restore is enabled:

1. Click the **Start** button and click **Control Panel**.
2. Click **Performance and Maintenance**.
3. Click **System**.
4. Click the **System Restore** tab.
5. Ensure that **Turn off System Restore** is unchecked.

Reinstalling Microsoft Windows XP

 **NOTICE:** You must use Windows XP Service Pack 1 or later when you reinstall your operating system.

Before You Begin

If you are considering reinstalling the Windows XP operating system to correct a problem with a newly installed driver, first try using Windows XP [Device Driver Rollback](#). If Device Driver Rollback does not resolve the problem, then use [System Restore](#) to return your operating system to the operating state it was in before you installed the new device driver.

- ➔ **NOTICE:** Before performing the installation, back up all data files on your primary hard drive. For conventional hard drive configurations, the primary hard drive is the first drive detected by the computer.

To reinstall Windows XP, you need the following items:

1. Dell™ *Operating System* CD
1. Dell *Drivers and Utilities* CD (*Resource* CD)

- 📌 **NOTE:** The *Drivers and Utilities* CD (*Resource* CD) contains drivers that were installed during assembly of the computer. Use the *Drivers and Utilities* CD to load any required drivers.

Reinstalling Windows XP

To reinstall Windows XP, perform all the steps in the following sections in the order in which they are listed.

The reinstallation process can take 1 to 2 hours to complete. After you reinstall the operating system, you must also reinstall the device drivers, virus protection program, and other software.

- ➔ **NOTICE:** The *Operating System* CD provides options for reinstalling Windows XP. The options can overwrite files and possibly affect programs installed on your hard drive. Therefore, do not reinstall Windows XP unless a Dell technical support representative instructs you to do so.
- ➔ **NOTICE:** To prevent conflicts with Windows XP, disable any virus protection software installed on your computer before you reinstall Windows XP. See the documentation that came with the software for instructions.

Booting From the Operating System CD

1. Save and close any open files and exit any open programs.
2. Insert the *Operating System* CD. Click **Exit** if **Install Windows XP** message appears.
3. Restart the computer.
4. Press <F12> immediately after the DELL™ logo appears.

If the operating system logo appears, wait until you see the Windows desktop, and then shut down the computer and try again.
5. Press the arrow keys to select **CD-ROM**, and press <Enter>.
6. When the **Press any key to boot from CD** message appears, press any key.

Windows XP Setup

1. When the **Windows XP Setup** screen appears, press <Enter> to select **To set up Windows now**.
2. Read the information on the **Microsoft Windows Licensing Agreement** screen, and press <F8> to accept the license agreement.
3. If your computer already has Windows XP installed and you want to recover your current Windows XP data, type **r** to select the repair option, and remove the CD.
4. If you want to install a new copy of Windows XP, press <Esc> to select that option.
5. Press <Enter> to select the highlighted partition (recommended), and follow the instructions on the screen.

The **Windows XP Setup** screen appears, and the operating system begins to copy files and install the devices. The computer automatically restarts multiple times.

- ➔ **NOTICE:** Do not press any key when the following message appears: **Press any key to boot from the CD**.

- 📌 **NOTE:** The time required to complete the setup depends on the size of the hard drive and the speed of your computer.

6. When the **Regional and Language Options** screen appears, select the settings for your location and click **Next**.
7. Enter your name and organization (optional) in the **Personalize Your Software** screen, and click **Next**.
8. At the **Computer Name and Administrator Password** window, enter a name for your computer (or accept the one provided) and a password, and click **Next**.

9. If the **Modem Dialing Information** screen appears, enter the requested information and click **Next**.
10. Enter the date, time, and time zone in the **Date and Time Settings** window, and click **Next**.
11. If the **Networking Settings** screen appears, click **Typical** and click **Next**.
12. If you are reinstalling Windows XP Professional and you are prompted to provide further information regarding your network configuration, enter your selections. If you are unsure of your settings, accept the default selections.

Windows XP installs the operating system components and configures the computer. The computer automatically restarts.

 **NOTICE:** Do not press any key when the following message appears: *Press any key to boot from the CD.*

13. When the **Welcome to Microsoft** screen appears, click **Next**.
14. When the *How will this computer connect to the Internet?* message appears, click **Skip**.
15. When the **Ready to register with Microsoft?** screen appears, select **No, not at this time** and click **Next**.
16. When the **Who will use this computer?** screen appears, you can enter up to five users.
17. Click **Next**.
18. Click **Finish** to complete the setup, and remove the CD.
19. [Reinstall the appropriate drivers](#) with the *Drivers and Utilities* CD (*Resource* CD).
20. Reinstall your virus protection software.
21. Reinstall your programs.

 **NOTE:** To reinstall and activate your Microsoft Office or Microsoft Works Suite programs, you need the Product Key number located on the back of the Microsoft Office or Microsoft Works Suite CD sleeve.

[Back to Contents Page](#)

Replacing the System Board

Dell™ OptiPlex™ 210L User's Guide

Removing the System Board

1. Shut down the computer through the Start menu.
2. Ensure that your computer and attached devices are turned off. If your computer and attached devices did not automatically turn off when you shut down your computer, turn them off now.

 **NOTICE:** To disconnect a network cable, first unplug the cable from your computer and then unplug it from the network wall jack.

3. Disconnect any telephone or telecommunication lines from the computer.
4. Disconnect your computer and all attached devices from their electrical outlets, and then press the power button to ground the system board.

 **CAUTION:** To guard against the electrical shock, always unplug your computer from the electrical outlet before removing the cover.

5. Remove the computer cover:
 1. Remove the [mini tower computer cover](#).
 1. Remove the [small desktop computer cover](#).

 **NOTICE:** Before touching anything inside your computer, ground yourself by touching an unpainted metal surface, such as the metal at the back of the computer. While you work, periodically touch an unpainted metal surface to dissipate any static electricity that could harm internal components.

6. Remove any components that restrict access to the system board (CD/DVD drive(s), floppy drive, hard drive, and I/O panel).
7. Remove the processor and heat sink assembly:
 1. Remove the [mini tower processor and heat sink assembly](#).
 1. Remove the [small desktop processor and heat sink assembly](#).
8. Disconnect all cables from the system board.
9. Remove the screws from the system board. See the illustrations below for screw locations:
 1. See "[Mini Tower System Board Screws](#)" for an illustration of the screw locations.
 1. See "[Small Desktop System Board Screws](#)" for an illustration of the screw locations.
10. Slide the system board assembly toward the front of the computer, and then lift the board up and away.

Mini Tower System Board Screws

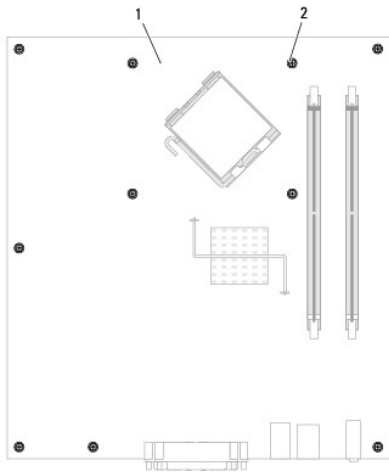

1	mini tower system board
2	screws (10)

Small Desktop System Board Screws

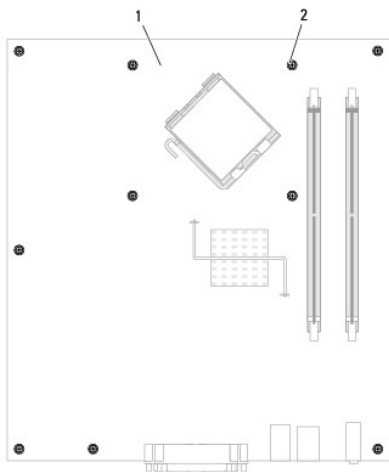

1	desktop system board
2	screws (10)

Place the system board assembly that you just removed next to the replacement system board to ensure it is identical.

Replacing the System Board

1. Gently align the board into the chassis and slide it toward the back of the computer.
2. Replace the screws on the system board.
3. Replace any components and cables that you removed from the system board.
4. Reconnect all cables to their connectors at the back of the computer.
5. [Replace the computer cover.](#)

Desktop Computer

Dell™ OptiPlex™ 210L User's Guide

- [About Your Desktop Computer](#)
- [Inside Your Computer](#)

About Your Desktop Computer

Front View

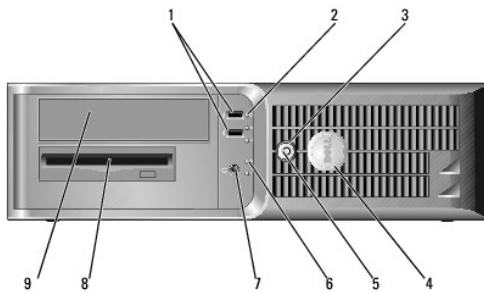

1	USB 2.0 connectors (2)	Use the USB connectors on the front of the computer for devices that you connect occasionally, such as joysticks or cameras, or for bootable USB devices (see " System Setup " for more information about booting to a USB device). It is recommended that you use the USB connectors on the back panel for devices that typically remain connected, such as printers and keyboards.
2	hard-drive activity light	This light flickers when the hard drive is being accessed.
3	power button	Press this button to turn on the computer. NOTICE: To avoid losing data, do not turn off the computer by pressing the power button for 6 seconds or longer. Instead, perform an operating system shutdown. NOTICE: If your operating system has ACPI enabled, when you press the power button the computer will perform an operating system shutdown.
4	Dell badge	This badge can be rotated to match the orientation of your computer. To rotate the badge, place your fingers around the outside of the badge, press firmly, and turn the badge. You can also rotate the badge using the slot provided near the bottom of the badge.
5	power light	The power light illuminates and blinks or remains solid to indicate different operating states: <ul style="list-style-type: none"> 1 No light — The computer is turned off. 1 Steady green — The computer is in a normal operating state. 1 Blinking green — The computer is in a power-saving mode. 1 Blinking or solid amber — See "Power Problems." <p>To exit from a power-saving mode, press the power button or use the keyboard or the mouse if it is configured as a wake device in the Windows Device Manager. For more information about sleep modes and exiting from a power-saving mode, see "Power Management."</p> <p>See "System Lights" for a description of light codes that can help you troubleshoot problems with your computer.</p>
6	diagnostic lights	Use the lights to help you troubleshoot a computer problem based on the diagnostic code. For more information, see " Diagnostic Lights ."
7	headphone connector	Use the headphone connector to attach headphones and most kinds of speakers.
8	floppy drive	Insert a floppy disk into this drive.
9	CD/DVD drive	Insert a CD or DVD (if applicable) into this drive.

Back View

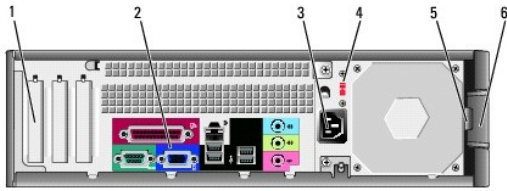

1	card slots	Access connectors for any installed PC Cards.
2	back-panel connectors	Plug serial, USB, and other devices into the appropriate connector.
3	power connector	Insert the power cable into this connector.
4	voltage selection switch	Your computer is equipped with a manual voltage-selection switch. To help avoid damaging a computer with a manual voltage-selection switch, set the switch for the voltage that most closely matches the AC power available in your location. NOTICE: In Japan the voltage selection switch must be set to the 115-V position. Also, ensure that your monitor and attached devices are electrically rated to operate with the AC power available in your location.
5	padlock ring	Insert a padlock to lock the computer cover.
6	cover release latch	Use this latch to open the computer cover.

Back-Panel Connectors

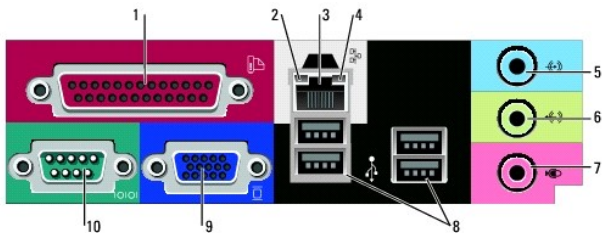

1	parallel connector	Connect a parallel device, such as a printer, to the parallel connector. If you have a USB printer, plug it into a USB connector. NOTE: The integrated parallel connector is automatically disabled if the computer detects an installed card containing a parallel connector configured to the same address. For more information, see " System Setup Options ."
2	link integrity light	<ul style="list-style-type: none"> 1 Green — A good connection exists between a 10-Mbps network and the computer. 1 Orange — A good connection exists between a 100-Mbps network and the computer. 1 Yellow — A good connection exists between a 1-Gbps (or 1000-Mbps) network and the computer. 1 Off — The computer is not detecting a physical connection to the network.
3	network adapter connector	To attach your computer to a network or broadband device, connect one end of a network cable to either a network jack or your network or broadband device. Connect the other end of the network cable to the network adapter connector on the back panel of your computer. A click indicates that the network cable has been securely attached. NOTE: Do not plug a telephone cable into the network connector. On computers with a network adapter card, use the connector on the card.

		It is recommended that you use Category 5 wiring and connectors for your network. If you must use Category 3 wiring, force the network speed to 10 Mbps to ensure reliable operation.
4	network activity light	This light flashes yellow when the computer is transmitting or receiving network data. A high volume of network traffic may make this light appear to be in a steady "on" state.
5	line-in connector	Use the blue line-in connector to attach a record/playback device such as a cassette player, CD player, or VCR. On computers with a sound card, use the connector on the card.
6	line-out connector	Use the green line-out connector to attach headphones and most speakers with integrated amplifiers. On computers with a sound card, use the connector on the card.
7	microphone connector	Use the pink microphone connector to attach a personal computer microphone for voice or musical input into a sound or telephony program. On computers with a sound card, the microphone connector is on the card.
8	USB 2.0 connectors (4)	Use the back USB connectors for devices that typically remain connected, such as printers and keyboards.
9	video connector	Plug the cable from your VGA-compatible monitor into the blue connector. NOTE: If you purchased an optional graphics card, this connector will be covered by a cap. Connect your monitor to the connector on the graphics card. Do not remove the cap. NOTE: If you are using a graphics card that supports dual monitors, use the y-cable that came with your computer.
10	serial connector	Connect a serial device, such as a handheld device, to the serial port. The default designation is COM1 for serial connector 1. For more information, see " System Setup Options ."

Inside Your Computer

CAUTION: Before you begin any of the procedures in this section, follow the safety instructions in the *Product Information Guide*.

CAUTION: To avoid electrical shock, always unplug your computer from the electrical outlet before removing the computer cover.

NOTICE: Be careful when opening the computer cover to ensure that you do not accidentally disconnect cables from the system board.

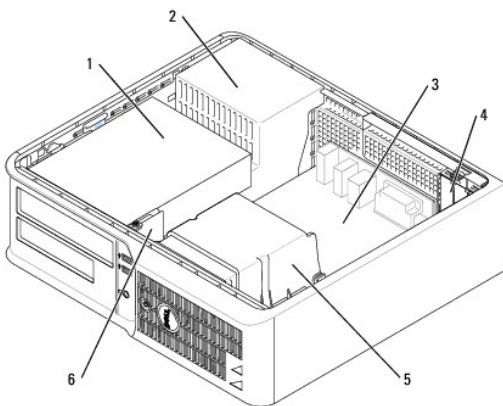

1 drives bay (CD/DVD, floppy, and hard drive)	4 card slots
2 power supply	5 heat sink assembly
3 system board	6 front I/O panel

System Board Components

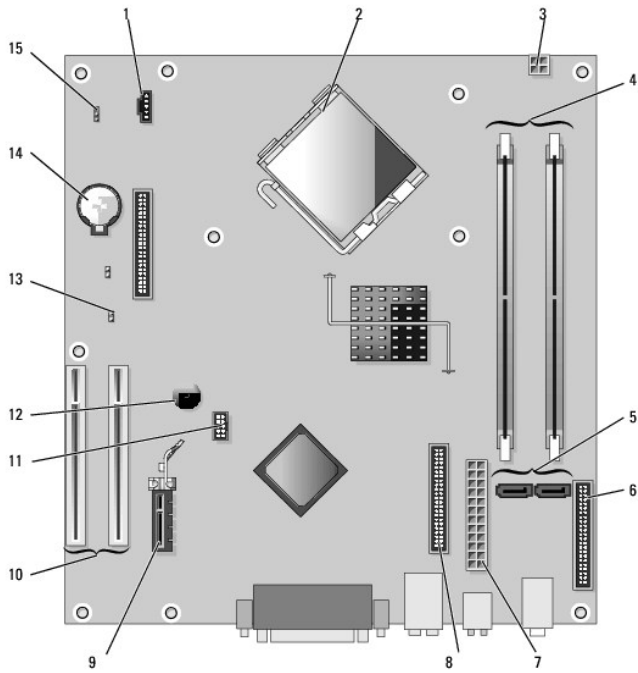



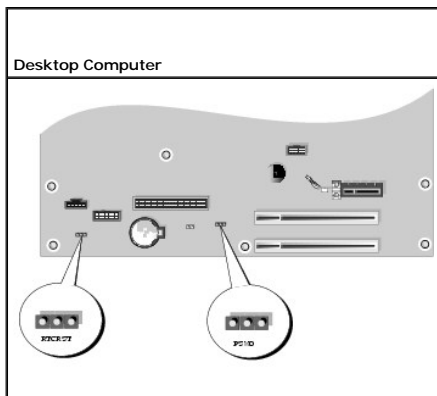

1	fan connector (FAN)	9	PCI Express x1 card connector
2	processor connector (CPU)	10	PCI card connector (2)
3	power connector (12VPOWER)	11	FlexBay USB connector
4	memory module connectors (DIMM_1, DIMM_2)	12	piezo buzzer
5	serial ATA drive connectors (SATA0, SATA2)	13	password jumper (PSWD)
NOTE: The SATA2 connector is not supported with this system.			
6	front-panel connector (FNT_PANEL)	14	battery socket (BATT)
7	power connector (POWER)	15	RTC reset jumper (RTCST)
8	CD/DVD drive connector (IDE)		

Jumper Settings



Jumper	Setting	Description
PSWD		Password features are enabled (default).

		Password features are disabled.
RTCST		The real-time clock has not been reset.
		The real-time clock is being reset (jumpered temporarily).
 <i>jumpered</i>  <i>unjumpered</i>		

[Back to Contents Page](#)

Dell™ OptiPlex™ 210L User's Guide

[PCI and PCI Express Cards](#)

PCI and PCI Express Cards

⚠ CAUTION: Before you begin any of the procedures in this section, follow the safety instructions in the *Product Information Guide*.

🔌 NOTICE: To prevent static damage to components inside your computer, discharge static electricity from your body before you touch any of your computer's electronic components. You can do so by touching an unpainted metal surface on the computer chassis.

Your Dell™ computer provides two low-profile PCI card slots for PCI cards:

🔌 NOTE: Your Dell computer uses only PCI slots. ISA cards are not supported.

PCI Cards

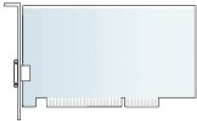

Installing a PCI Card

1. Follow the procedures in "[Before You Begin](#)."
2. Gently push the release tab on the card retention latch.
3. If you are installing a new card, remove the filler bracket to create a card-slot opening. Then continue with step 5.
4. If you are replacing a card that is already installed in the computer, remove the card. If necessary, disconnect any cables connected to the card.
5. Prepare the card for installation.

🔌 NOTE: See the documentation that came with the card for information on configuring the card, making internal connections, or customizing it for your computer.

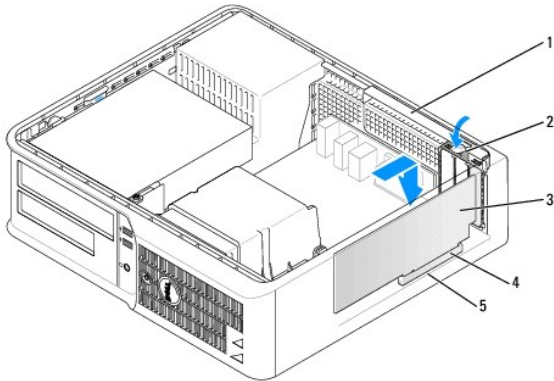

1	card retention latch
2	release tab
3	card
4	card-edge connector
5	card connector

⚠ CAUTION: Some network adapters automatically start the computer when they are connected to a network. To guard against electrical shock, be sure to unplug your computer from its electrical outlet before installing any cards.

6. Place the card in the connector and press down firmly. Ensure that the card is fully seated in the slot.

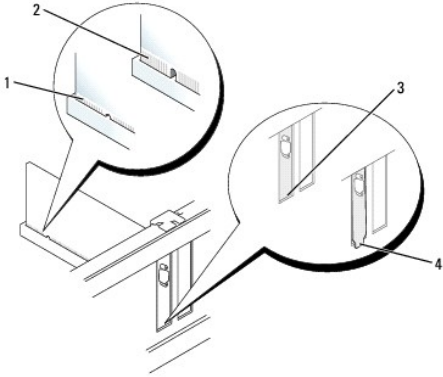

1	card fully seated
2	card not fully seated
3	bracket within slot
4	bracket caught outside of slot

7. Gently press down on the card retention latch to secure the card.

➡ **NOTICE:** Do not route card cables over or behind the cards. Cables routed over the cards can prevent the computer cover from closing properly or cause damage to the equipment.

8. Connect any cables that should be attached to the card.

➡ **NOTICE:** To connect a network cable, first plug the cable into the network wall jack and then plug it into the computer.

9. If you installed a sound card:

- [Enter system setup](#), select **Audio Controller**, and change the setting to **Off**.
- Connect external audio devices to the sound card's connectors. Do not connect external audio devices to the microphone, speaker/headphone, or line-in connectors on the back or front panel.

10. If you installed a network adapter card and want to turn off the integrated network adapter:

- [Enter system setup](#), select **Network Controller**, and change the setting to **Off**.
- Connect the network cable to the network adapter card's connectors. Do not connect the network cable to the integrated network connector on the back panel.

11. Install any drivers required for the card as described in the card documentation.

Removing a PCI Card

- Follow the procedures in "[Before You Begin](#)."
- Gently push the release tab on the card retention latch and swing it outward.
- If necessary, disconnect any cables connected to the card.
- Grasp the card by its top corners, and ease it out of its connector.

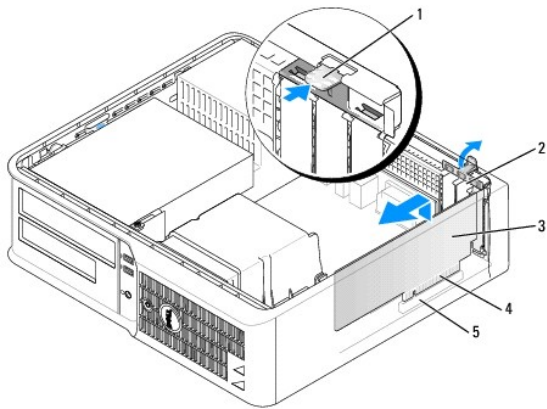

1	release tab	4	card-edge connector
2	card retention latch	5	card connector
3	card		

- If you are removing the card permanently, install a filler bracket in the empty card-slot opening.

If you need a filler bracket, [contact Dell](#).

NOTE: Installing filler brackets over empty card-slot openings is necessary to maintain FCC certification of the computer. The brackets also keep dust and dirt out of your computer.

- Snap the card retention latch into place.

NOTICE: To connect a network cable, first plug the cable into the network wall jack and then plug it into the computer.

- [Replace the computer cover](#).

- Uninstall the card's driver. See the documentation that came with the card for instructions.

- If you removed a sound card:
 - [Enter system setup](#), select **Audio Controller**, and change the setting to **On**.
 - Connect external audio devices to the audio connectors on the computer back panel.

- If you removed a network adapter card:
 - [Enter system setup](#), select **Network Controller**, and change the setting to **On**.
 - Connect the network cable to the integrated network connector on the back panel of the computer.

Dell™ OptiPlex™ 210L User's Guide

● [Removing the Computer Cover](#)

Removing the Computer Cover

⚠ CAUTION: Before you begin any of the procedures in this section, follow the safety instructions in the *Product Information Guide*.

⚠ CAUTION: To guard against electrical shock, always unplug your computer from the electrical outlet before removing the computer cover.

1. Follow the procedures in "[Before You Begin](#)."
2. If you have installed a padlock through the padlock ring on the back panel, remove the padlock.
3. Slide the cover release latch back as you lift the cover.
4. Pivot the cover up using the hinge tabs as leverage points.
5. Remove the cover from the hinge tabs and set it aside on a soft nonabrasive surface.

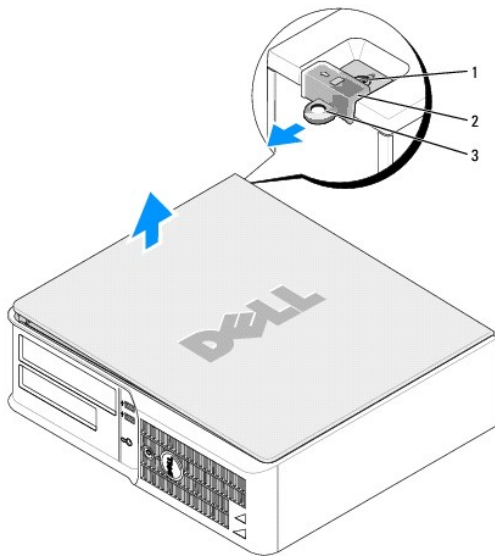

1	security cable slot
2	cover release latch
3	padlock ring

Dell™ OptiPlex™ 210L User's Guide

• [Drives](#)

Drives

Your computer supports:

- 1 One serial ATA hard drive
- 1 One optional ATA hard drive
- 1 One optional floppy drive
- 1 One optional CD or DVD drive

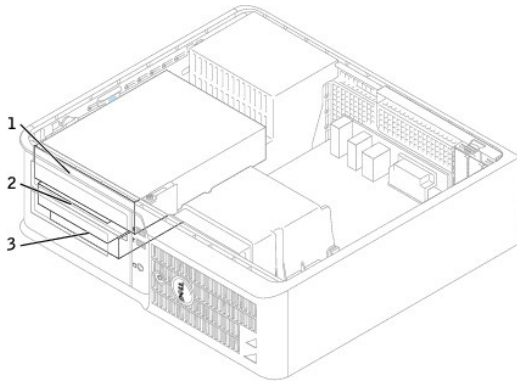

1	CD/DVD drive
2	floppy drive
3	hard drive

General Installation Guidelines

Connect CD/DVD drives to the connector labeled "IDE" on the [system board](#). Serial ATA hard drives should be connected to the connectors labeled "SATA0" or "SATA2" on the [system board](#).

Connecting Drive Cables

When you install a drive, you connect two cables—a DC power cable and a data cable—to the back of the drive and to the system board.

Drive Interface Connectors

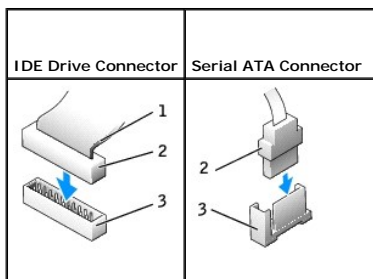

1	colored stripe on IDE cable
2	interface cable connector
3	interface connector

Most interface connectors are keyed for correct insertion; that is, a notch or a missing pin on one connector matches a tab or a filled-in hole on the other connector. Keyed connectors ensure that the pin-1 wire in the cable (indicated by the colored stripe along one edge of the IDE cable—serial ATA cables do not use a colored stripe) goes to the pin-1 end of the connector. The pin-1 end of a connector on a board or a card is usually indicated by a silk-screened "1" printed directly on the board or card.

🔗 **NOTICE:** When you connect an IDE interface cable, do not place the colored stripe away from pin 1 of the connector. Reversing the cable prevents the drive from operating and could damage the controller, the drive, or both.

Power Cable Connectors

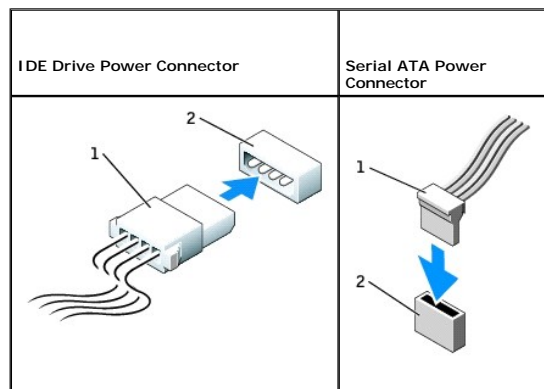

1	power cable
2	power input connector

Connecting and Disconnecting Drive Cables

When removing an IDE drive data cable, grasp the colored pull-tab and pull until the connector detaches.

When connecting and disconnecting a serial ATA data cable, hold the cable by the black connector at each end.

Like IDE connectors, the serial ATA interface connectors are keyed for correct insertion; that is, a notch or a missing pin on one connector matches a tab or a filled-in hole on the other connector.

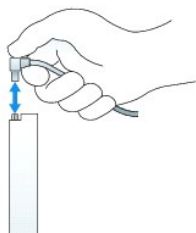

CD/DVD Drive

⚠️ **CAUTION:** Before you begin any of the procedures in this section, follow the safety instructions in the *Product Information Guide*.

⚠️ **CAUTION:** To guard against electrical shock, always unplug your computer from the electrical outlet before removing the computer cover.

Removing a CD/DVD Drive

1. Follow the procedures in "[Before You Begin](#)."

🔗 **NOTICE:** Do not pull the drive out of the computer by the drive cables. Doing so may cause damage to cables and the cable connectors.

2. Pull up on the drive release latch and slide the drive towards the back of the computer. Then, lift up to remove the drive from the computer.

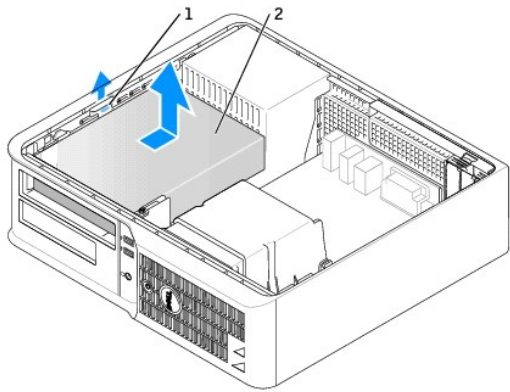

1	drive release latch
2	CD/DVD drive

3. Disconnect the power and CD/DVD drive cables from the back of the drive.

Installing a CD/DVD Drive

1. Unpack the drive and prepare it for installation.

Check the documentation that accompanied the drive to verify that the drive is configured for your computer. If you are installing an IDE drive, configure the drive for the cable select setting.

2. If you are installing a new drive:
 - a. Press the two snaps on the top of the drive-panel insert and rotate the insert toward the front of the computer.
 - b. Remove the three shoulder screws from the drive-panel insert.
3. If you are replacing an existing drive:
 - a. Press the two snaps on the top of the drive-panel insert and rotate the insert toward the front of the computer.
 - b. Remove the three shoulder screws from the existing drive.
 - c. Insert the three shoulder screws into the sides of the new drive and tighten them.

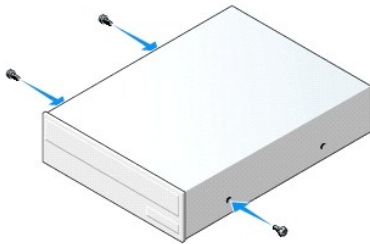

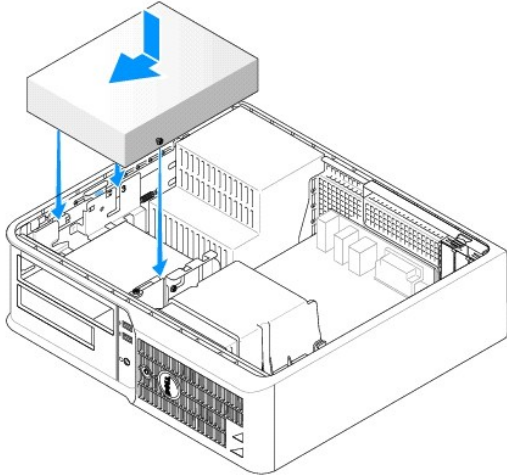

4. Connect the power and CD/DVD drive cables to the drive.
5. Align the shoulder screws with the screw guides, and slide the drive into the bay until it clicks into place.





6. Check all cable connections, and fold cables out of the way to provide airflow for the fan and cooling vents.
7. [Replace the computer cover.](#)
8. Update your configuration information by setting the appropriate **Drive** option (**0** or **1**) under **Drives**. See "[System Setup](#)" for more information.
9. Verify that your computer works correctly by running the [Dell Diagnostics](#).

Floppy Drive

-  **CAUTION:** Before you begin any of the procedures in this section, follow the safety instructions in the *Product Information Guide*.
-  **CAUTION:** To guard against electrical shock, always unplug your computer from the electrical outlet before removing the computer cover.

Removing a Floppy Drive

1. Follow the procedures in "[Before You Begin](#)."
-  **NOTE:** Since the following steps do not require the complete removal of the CD/DVD drive, it is not necessary to disconnect the cables connecting the CD/DVD drive.
2. [Remove the CD/DVD drive](#) and carefully set it aside.
-  **NOTICE:** Do not pull the drive out of the computer by the drive cables. Doing so may cause damage to cables and the cable connectors.
3. Pull up on the drive release latch and slide the floppy drive towards the back of the computer. Then, lift up to remove the drive from the computer.

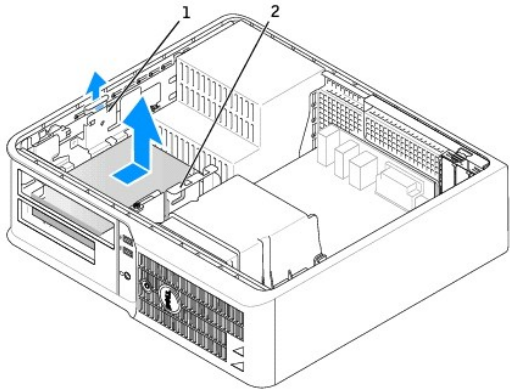

1	drive release latch
2	floppy drive

4. Disconnect the power and floppy-drive cables from the back of the floppy drive.

Installing a Floppy Drive

1. If you are installing a new drive:
 - a. Use a small flat-edge screw driver on the back side of the drive-panel insert to gently pop off the insert.
 - b. Remove the four shoulder screws from the drive-panel insert.
2. If you are replacing an existing drive:

Remove the four shoulder screws from the existing drive.
3. Insert the four shoulder screws into the sides of the new floppy drive and tighten them.

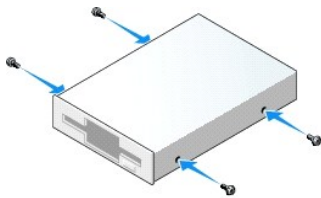

4. Attach the power and floppy-drive cables to the floppy drive.
5. Align the shoulder screws with the screw guides, and slide the drive into the bay until it clicks into place.

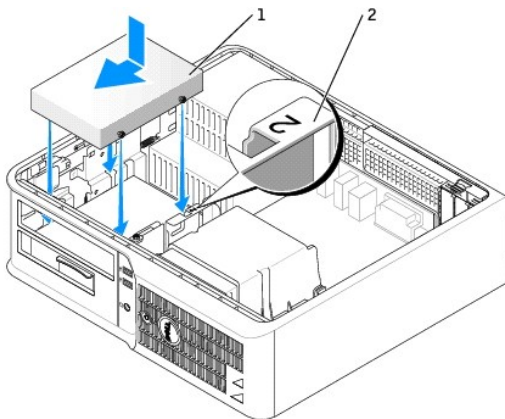

1	power cable
---	-------------

2	slot verification number
---	--------------------------

6. [Replace the CD/DVD drive.](#)
7. Check all cable connections, and fold cables out of the way to provide airflow for the fan and cooling vents.
8. [Replace the computer cover.](#)
9. [Enter system setup](#) and set the **Diskette Drive** option to enable your new floppy drive.
10. Verify that your computer works correctly by running the [Dell Diagnostics](#).

Hard Drive

- ⚠ **CAUTION:** Before you begin any of the procedures in this section, follow the safety instructions in the *Product Information Guide*.
- ⚠ **CAUTION:** To guard against electrical shock, always unplug your computer from the electrical outlet before removing the computer cover.
- 👉 **NOTICE:** To avoid damage to the drive, do not set it on a hard surface. Instead, set the drive on a surface, such as a foam pad, that will sufficiently cushion it.

1. If you are replacing a hard drive that contains data you want to keep, back up your files before you begin this procedure.
2. Check the documentation for the drive to verify that it is configured for your computer.

Removing a Hard Drive

1. Follow the procedures in "[Before You Begin.](#)"
- 📌 **NOTE:** Since the following steps do not require the complete removal of the CD/DVD drive and the floppy drive, it is not necessary to disconnect the cables connecting the two drives.
2. [Remove the CD/DVD drive](#) from the bay and carefully set it aside.
 3. [Remove the floppy drive](#) from the bay and carefully set it aside.
 4. Press in on the two plastic securing clips on each side of the drive and slide the drive towards the back of the computer.
- 👉 **NOTICE:** Do not pull the drive out of the computer by the drive cables. Doing so may cause damage to cables and the cable connectors.
5. Lift the drive out of the computer and disconnect the power and hard-drive cables from the drive.

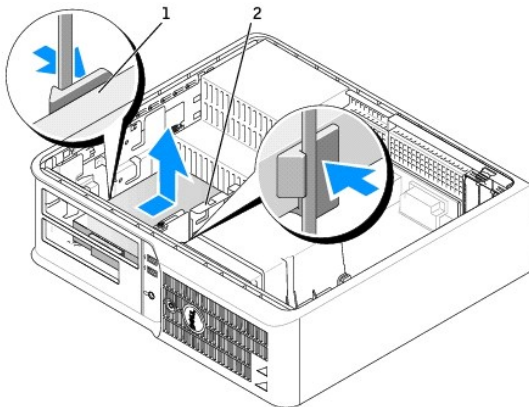

1	securing clips (2)
2	hard drive

Installing a Hard Drive

1. Check the documentation for the drive to verify that it is configured for your computer.

NOTICE: To avoid damage to the drive, do not set it on a hard surface. Instead, set the drive on a surface, such as a foam pad, that will sufficiently cushion it.

2. Unpack the replacement hard drive, and prepare it for installation.
3. If your replacement hard drive does not have the plastic hard-drive bracket attached, remove the bracket from the existing drive by unsnapping it from the drive.

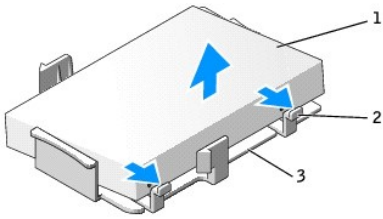

1	hard drive
2	release tabs (2)
3	plastic hard-drive bracket

4. Attach the bracket to the new drive by snapping it onto the drive.

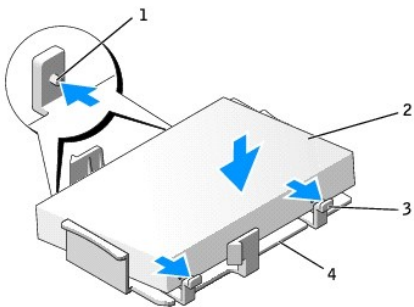

1	securing tabs (2)	3	release tabs (2)
2	drive	4	plastic hard-drive bracket

5. Connect the power and hard-drive cables to the drive.
6. Locate the correct slot for the drive, and slide the drive into the bay until it clicks into place.

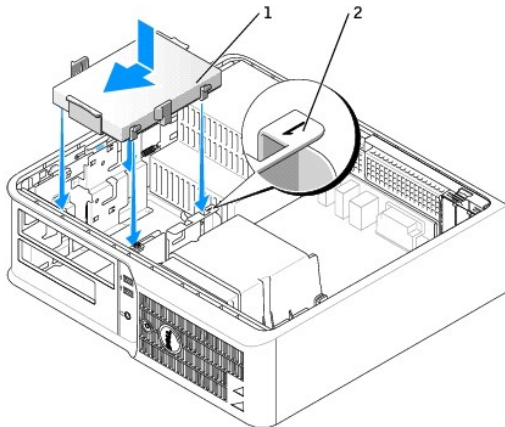

1	hard drive
2	slot verification number

7. Replace the floppy drive and CD/DVD drive.
8. Check all connectors to be certain that they are properly cabled and firmly seated.
9. [Replace the computer cover.](#)
10. If the drive you just installed is the primary drive, insert a bootable medium into your boot drive.
11. Turn on the computer.
12. [Enter system setup](#) and update the appropriate **Primary Drive** option (**0** or **2**).
13. Exit system setup, and reboot the computer.
14. Partition and logically format your drive before you proceed to the next step.
For instructions, see the documentation that came with your operating system.
15. Test the hard drive by running the [Dell Diagnostics](#).
16. Install your operating system on the hard drive.
For instructions, see the documentation that came with your operating system.

[Back to Contents Page](#)

Dell™ OptiPlex™ 210L User's Guide

Desktop Computer



[Finding Information](#)

[Before You Begin](#)

[Recommended Tools](#)

[Turning Off Your Computer](#)

[Before Working Inside Your Computer](#)

[Desktop Computer](#)

[About Your Desktop Computer](#)

[Inside Your Computer](#)

[Desktop Computer Specifications](#)

[Removing the Computer Cover](#)

[I/O Panel](#)

[Drives](#)

[PCI and PCI Express Cards](#)

[Power Supply](#)

[Processor](#)

[Advanced Features](#)

[LegacySelect Technology Control](#)

[Manageability](#)

[Security](#)

[Password Protection](#)

[System Setup](#)

[Rooting to a USB Device](#)

[Clearing Forgotten Passwords](#)

[Clearing CMOS Settings](#)

[Hyper-Threading](#)

[Power Management](#)

[Battery](#)

[Replacing the Battery](#)

[Replacing the System Board](#)

[Memory](#)

[DDR2 Memory Overview](#)

[Addressing Memory With 4-GB Configurations](#)

[Removing Memory](#)

[Replacing/Adding Additional Memory](#)

[Replacing the Computer Cover](#)

[Cleaning Your Computer](#)

[Reinstalling Drivers and the Operating System](#)

[Drivers](#)

[Using Microsoft® Windows® XP System Restore](#)

[Reinstalling Microsoft Windows XP](#)

[Solving Problems](#)

[Battery Problems](#)

[Drive Problems](#)

[Keyboard Problems](#)

[Lockups and Software Problems](#)

[Memory Problems](#)

[Mouse Problems](#)

[Network Problems](#)

[Power Problems](#)

[Printer Problems](#)

[Restoring Default Settings](#)

[Serial or Parallel Device Problems](#)

[Sound and Speaker Problems](#)

[Video and Monitor Problems](#)

[Microsoft® Windows® XP Features](#)

[Transferring Information to a New Computer](#)

[User Accounts and Fast User Switching](#)

[Setting Up a Home and Office Network](#)

[Glossary](#)

[Troubleshooting Tools and Utilities](#)

[Dell Diagnostics](#)

[System Lights](#)

[Diagnostic Lights](#)

[Beep Codes](#)

[Error Messages](#)

[Resolving Software and Hardware Incompatibilities](#)

[Getting Help](#)

[Technical Assistance](#)

[Problems With Your Order](#)

[Product Information](#)

[Returning Items for Warranty Repair or Credit](#)



[Before You Call](#)

[Contacting Dell](#)

[Warranty](#)

[FCC Notices \(U.S. Only\)](#)

Notes, Notices, and Cautions

-  **NOTE:** A NOTE indicates important information that helps you make better use of your computer.
-  **NOTICE:** A NOTICE indicates either potential damage to hardware or loss of data and tells you how to avoid the problem.
-  **CAUTION:** A CAUTION indicates a potential for property damage, personal injury, or death.

Abbreviations and Acronyms

For a complete list of abbreviations and acronyms, see the [Glossary](#).

If you purchased a Dell™ n Series computer, any references in this document to Microsoft® Windows® operating systems are not applicable.

Information in this document is subject to change without notice.
© 2006 Dell Inc. All rights reserved.

Reproduction in any manner whatsoever without the written permission of Dell Inc. is strictly forbidden.

Trademarks used in this text: Dell, the DELL logo, OptiPlex, Inspiron, Dimension, Latitude, Dell Precision, DellNet, TravelLite, Dell OpenManage, PowerVault, Axim, PowerEdge, PowerConnect, and PowerApp are trademarks of Dell Inc.; Intel, Pentium, and Celeron are registered trademarks of Intel Corporation; Microsoft, MS-DOS, and Windows are registered trademarks of

Microsoft Corporation: *IBM* is a registered trademark of International Business Machines Corporation; *Bluetooth* is a trademark owned by Bluetooth SIG, Inc. and is used by Dell Inc. under license. *ENERGY STAR* is a registered trademark of the U.S. Environmental Protection Agency. As an ENERGY STAR partner, Dell Inc. has determined that this product meets the ENERGY STAR guidelines for energy efficiency.

Other trademarks and trade names may be used in this document to refer to either the entities claiming the marks and names or their products. Dell Inc. disclaims any proprietary interest in trademarks and trade names other than its own.

Models: DCTR and DCNE

July 2006 P/N GD045 Rev. A02

Dell™ OptiPlex™ 210L User's Guide

[I/O Panel](#)

I/O Panel

Removing the I/O Panel

⚠ CAUTION: Before you begin any of the procedures in this section, follow the safety instructions located in the *Product Information Guide*.

⚠ CAUTION: To guard against electrical shock, always unplug your computer from the electrical outlet before removing the cover.

🔧 NOTE: Note the routing of all cables before disconnecting them, so that you can re route them correctly when installing the new I/O panel.

1. Follow the procedures in "[Before You Begin](#)."
2. Remove the cable from the I/O panel by pulling on the pull-loop.
3. Remove the screw that secures the I/O panel to the desktop computer.

🕒 NOTICE: When sliding the I/O panel out of the computer, be extremely careful. Carelessness may result in damage to the cable connectors and the cable routing clips.

4. Gently rotate and slide the I/O panel away from the computer.

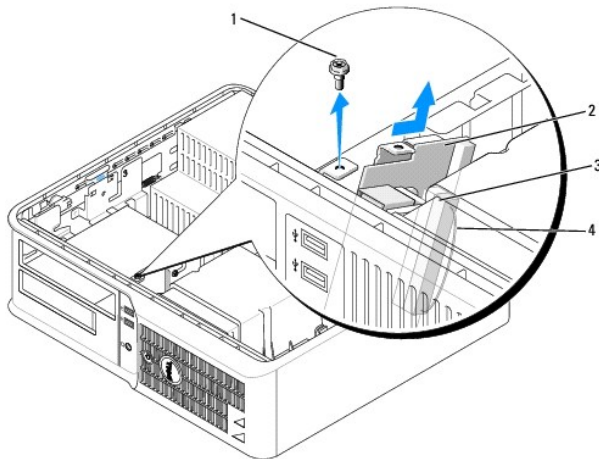

1	securing screw
2	I/O panel
3	I/O cable connector
4	I/O connector pull-loop

Replacing the I/O Panel

1. To replace the I/O panel, follow the removal procedures in the reverse order.

🔧 NOTE: Use the guides on the I/O panel bracket to help position the I/O panel in place and use the notch on the I/O panel bracket to help seat the card.

Dell™ OptiPlex™ 210L User's Guide

Processor

Processor

⚠ CAUTION: Before you begin any of the procedures in this section, follow the safety instructions located in the *Product Information Guide*.

🔌 NOTICE: To prevent static damage to components inside your computer, discharge static electricity from your body before you touch any of your computer's electronic components. You can do so by touching an unpainted metal surface on the computer chassis.

Removing the Processor

1. Follow the procedures in "[Before You Begin](#)."
2. Loosen the captive screw on each side of the heat sink assembly.

⚠ CAUTION: Despite having a plastic shield, the heat sink assembly may be very hot during normal operation. Be sure that it has had sufficient time to cool before you touch it.

3. Rotate the heat sink assembly upward, and remove the assembly from the computer.

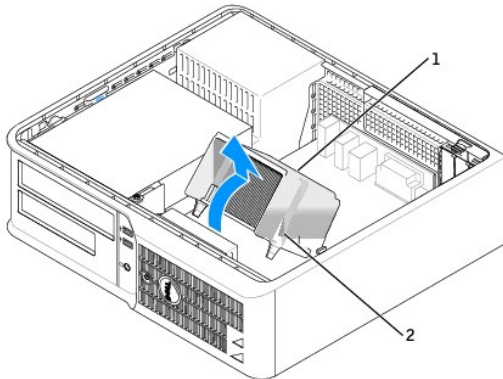

1	heat sink assembly
2	captive screw housing (2)

🔌 NOTICE: If you are installing a processor upgrade kit from Dell, discard the original heat sink. If you are *not* installing a processor upgrade kit from Dell, reuse the original heat sink when you install your new processor.

4. Open the processor cover by sliding the release lever from under the center cover latch on the socket. Then pull the lever back to release the processor.

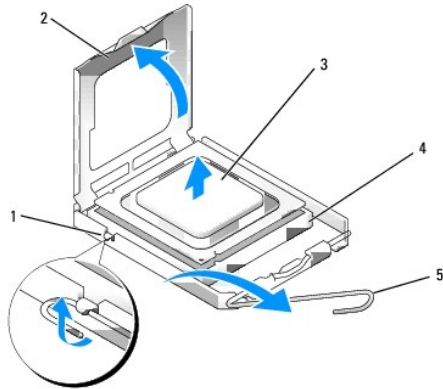

1	center cover latch
2	processor cover
3	processor
4	socket
5	release lever

➡ **NOTICE:** When replacing the processor, do not touch any of the pins inside the socket or allow any objects to fall on the pins in the socket.

5. Gently remove the processor from the socket.

Leave the release lever extended in the release position so that the socket is ready for the new processor.

Installing the Processor

➡ **NOTICE:** Ground yourself by touching an unpainted metal surface on the back of the computer.

➡ **NOTICE:** When replacing the processor, do not touch any of the pins inside the socket or allow any objects to fall on the pins in the socket.

1. Follow the procedures in "[Before You Begin.](#)"

2. Unpack the new processor, being careful not to touch the underside of the processor.

➡ **NOTICE:** You must position the processor correctly in the socket to avoid permanent damage to the processor and the computer when you turn on the computer.

3. If the release lever on the socket is not fully extended, move it to that position.

4. Orient the front and rear alignment-notches on the processor with the front and rear alignment-notches on the socket.

5. Align the pin-1 corners of the processor and socket.

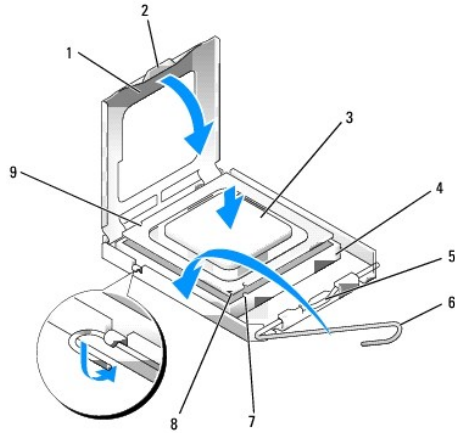

1	processor cover	6	release lever
2	tab	7	front alignment-notch
3	processor	8	socket and processor pin-1 indicator
4	processor socket	9	rear alignment-notch
5	center cover latch		

➔ **NOTICE:** To avoid damage, ensure that the processor aligns properly with the socket, and do not use excessive force when you install the processor.

6. Set the processor lightly in the socket and ensure that the processor is positioned correctly.

7. When the processor is fully seated in the socket, close the processor cover.

Ensure that the tab on the processor cover is positioned underneath the center cover latch on the socket.

8. Pivot the socket release lever back toward the socket, and snap it into place to secure the processor.

➔ **NOTICE:** If you are *not* installing a processor upgrade kit from Dell, reuse the original heat sink assembly when you replace the processor.

If you installed a processor replacement kit from Dell, return the original heat sink assembly and processor to Dell in the same package in which your replacement kit was sent.

9. Install the heat sink assembly:

- Place the heat sink assembly back onto the heat-sink assembly bracket.
- Rotate the heat sink assembly down towards the computer base and tighten the two captive screws.

➔ **NOTICE:** Ensure that the heat sink assembly is correctly seated and secure.

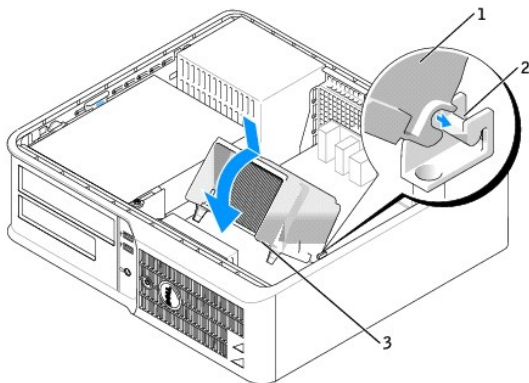

1	heat sink assembly
2	heat-sink assembly bracket

3 | captive screw housing (2) |

10. [Replace the computer cover.](#)

[Back to Contents Page](#)

Power Supply

Replacing the Power Supply

⚠ CAUTION: Before you begin any of the procedures in this section, follow the safety instructions located in the *Product Information Guide*.

🔌 NOTICE: To prevent static damage to components inside your computer, discharge static electricity from your body before you touch any of your computer's electronic components. You can do so by touching an unpainted metal surface on the computer chassis.

1. Follow the procedures in "[Before You Begin](#)."
2. Disconnect the DC power cables from the system board and the drives.

Note the routing of the DC power cables underneath the tabs in the computer chassis as you remove them from the system board and drives. You must route these cables properly when you replace them to prevent their being pinched or crimped.

3. Remove the two screws that attach the power supply to the back of the computer chassis.
4. Remove the CD/DVD drive and carefully set it aside.
5. Press the release button located on the floor of the computer chassis.

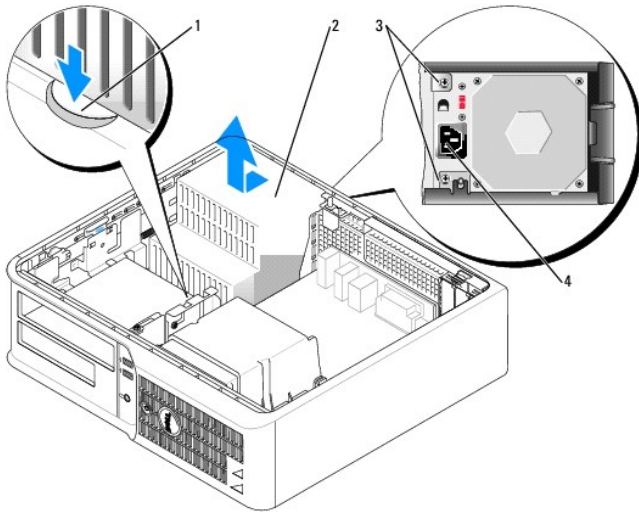

1	release button
2	power supply
3	screws (2)
4	AC power connector

6. Slide the power supply toward the front of the computer by approximately 1 inch.
7. Lift the power supply up and out of the computer.
8. Slide the replacement power supply into place.
9. Replace the screws that secure the power supply to the back of the computer chassis.
10. Reconnect the DC power cables.

11. Replace the CD/DVD drive.
12. Connect the AC power cable to the connector.
13. [Replace the computer cover.](#)

DC Power Connectors

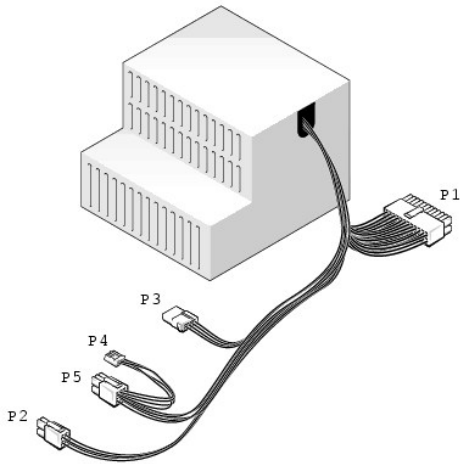

DC Power Connector P1

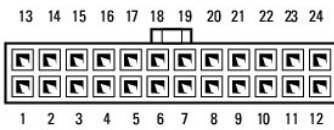

Pin Number	Signal name	18-AWG Wire
1	+3.3 VDC	Orange
2	+3.3 VDC	Orange
3	GND	Black
4	+5 VDC	Red
5	GND	Black
6	+5 VDC	Red
7	GND	Black
8	PS_PWROK*	Gray
9	P5AUX	Purple
10	+12 VDC	White
11	+12 VDC	White
12	+3.3 VDC	Orange
13	+3.3 VDC	Orange
14	-12 VDC*	Blue
15	GND	Black
16	PWR_PS_ON*	Green
17	GND	Black
18	GND	Black
19	GND	Black
20	NC	N/C
21	+5 VDC	Red

22	+5 VDC	Red
23	+5 VDC	Red
24	GND	Black

*Uses 22-AWG wire instead of 18-AWG wire.

DC Power Connector P2



Pin Number	Signal Name	18-AWG Wire
1	GND	Black
2	GND	Black
3	+12 VDC	Yellow
4	+12 VDC	Yellow

DC Power Connector P3

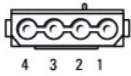

Pin Number	Signal name	18-AWG Wire
1	+12 VDC	Yellow
2	GND	Black
3	GND	Black
4	+5 VDC	Red

DC Power Connector P4

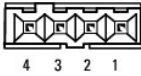

Pin Number	Signal Name	22-AWG Wire
1	+5 VCD	Red
2	GND	Black
3	GND	Black
4	+12 VDC	Yellow

DC Power Connector P5



--	--	--

Pin Number	Signal name	18-AWG Wire
1	+3.3 VDC	Orange
2	COM	Black
3	+5 VDC	Red
4	GND	Black
5	+12 VDC	Yellow

[Back to Contents Page](#)

Dell™ OptiPlex™ 210L User's Guide

• [Desktop Computer Specifications](#)

Desktop Computer Specifications

Microprocessor	
Microprocessor type	Intel® Pentium® or Celeron® processor
Level 1 (L1) cache	32 KB
Level 2 (L2) cache	512-KB, 1-MB, or 2-MB pipelined-burst, eight-way set associative, write-back SRAM

Memory	
Type	400-MHz and 533-MHz DDR2 SDRAM
Memory connectors	2
Memory modules supported	256-MB, 512-MB, 1-GB or 2-GB non-ECC
Minimum memory	dual-channel: 512 MB single-channel: 256 MB
Maximum memory	4 GB
BIOS address	F0000h

Computer Information	
Chipset	Intel® 915GV
Data bus width	64 bits
Address bus width	32 bits
DMA channels	eight
Interrupt levels	24
BIOS chip (NVRAM)	4 Mb
Memory speed	400 MHz and 533 MHz
NIC	integrated network interface capable of 10/100 communication: <ul style="list-style-type: none">1 Green — A good connection exists between a 10-Mbps network and the computer.1 Orange — A good connection exists between a 100-Mbps network and the computer.1 Off — The computer is not detecting a physical connection to the network.

Video	
Type	integrated Intel Graphic Media Accelerator 900

Audio	
Type	SigmaTel STAC9200
Stereo conversion	16-bit analog-to-digital; 20-bit digital-to-analog

Controllers	
Drives	two serial ATA controllers supporting one device each and one parallel Ultra ATA/100 IDE supporting two devices per channel with one channel

Other	
--------------	--

Expansion Bus	
Bus type	PCI 2.3 SATA 1.0a USB 2.0
Bus speed	PCI: 33 MHz SATA: 1.5 Gbps and 3.0 Gbps USB: 480 Mbps
Cards	low-profile cards supported
PCI:	
connectors	two
card size	low profile
connector size	120 pins
connector data width (maximum)	32 bits
PCI Express:	
connectors	one x1
power	10 W maximum
connector size	36 pins
connector data width (maximum)	one PCI Express lane

Drives	
Externally accessible	one 3.5-inch drive one bay for CD/DVD or optional second hard drive
Internally accessible	one bay for a 1-inch-high hard drive

Connectors	
External connectors:	
Serial	9-pin connector; 16550C-compatible
Parallel	25-hole connector (bidirectional)
Video	15-hole VGA connector
Network adapter	RJ45 connector
USB	two front-panel and four back-panel USB 2.0-compliant connectors
Audio	three back connectors for line-in, line-out, and microphone; one front-panel connector for headphones
System board connectors:	
Primary IDE drive	40-pin connector
Serial ATA	two 7-pin connectors (only one used) NOTE: The SATA2 connector is not supported on this system.
Floppy drive	34-pin connector
Fan	5-pin connector
PCI 2.3	120-pin connector
CD drive audio interface	4-pin connector
Front panel	40-pin connector

Key Combinations	
<Ctrl><Alt>	in Microsoft® Windows® XP, brings up the Windows Security window; in DOS mode, restarts (reboots) the computer
<F2> or <Ctrl><Alt><Enter>	starts embedded system setup (during system start-up only)
<Ctrl><Alt>	automatically starts the computer from the network environment specified by the remote boot environment (PXE) rather than from one of the devices in the system setup Boot Sequence option (during system start-up only)
<F12> or <Ctrl><Alt><F8>	displays a boot device menu that allows the user to enter a device for a single boot (during system start-up only) as well as options to run hard-drive and

Controls and Lights	
Power control	push button
Power light	green light — Blinking green indicates a sleep mode; solid green indicates a power-on state. amber light — Blinking amber indicates a problem with an installed device; solid amber indicates an internal power problem (see " Power Problems ").
Hard-drive access light	green
Link light	solid green light indicates network connection
Link integrity light (on integrated network adapter)	green light for 10-Mb operation and orange light for 100-Mb operation
Activity light (on integrated network adapter)	yellow blinking light
Diagnostic lights	four lights on the front panel (see " Diagnostic Lights ")
Standby power light	AUX_PWR on the system board

Power	
DC power supply:	
Wattage	220 W
Heat dissipation	751 BTU/hr NOTE: Heat dissipation is calculated based upon the power supply wattage rating.
Voltage	manual selection power supplies — 90 to 135 V at 50/60 Hz; 180 to 265 V at 50/60 Hz
Backup battery	3-V CR2032 lithium coin cell

Physical	
Height	11.4 cm (4.5 inches)
Width	39.9 cm (15.7 inches)
Depth	35.3 cm (13.9 inches)
Weight	10.4 kg (23 lb)

Environmental	
Temperature:	
Operating	10° to 35°C (50° to 95°F)
Storage	-40° to 65°C (-40° to 149°F)
Relative humidity	20% to 80% (noncondensing)
Maximum vibration:	
Operating	0.25 G at 3 to 200 Hz at 0.5 octave/min
Storage	0.5 G at 3 to 200 Hz at 1 octave/min
Maximum shock:	
Operating	bottom half-sine pulse with a change in velocity of 50.8 cm/sec (20 inches/sec)
Storage	27-G faired square wave with a velocity change of 508 cm/sec (200 inches/sec)
Altitude:	
Operating	-15.2 to 3048 m (-50 to 10,000 ft)
Storage	-15.2 to 10,668 m (-50 to 35,000 ft)

[Back to Contents Page](#)

Solving Problems

Dell™ OptiPlex™ 210L User's Guide

- [Battery Problems](#)
- [Drive Problems](#)
- [Keyboard Problems](#)
- [Lockups and Software Problems](#)
- [Memory Problems](#)
- [Mouse Problems](#)
- [Network Problems](#)
- [Power Problems](#)
- [Printer Problems](#)
- [Restoring Default Settings](#)
- [Serial or Parallel Device Problems](#)
- [Sound and Speaker Problems](#)
- [Video and Monitor Problems](#)

Battery Problems

Fill out the [Diagnostics Checklist](#) before you complete these checks.

 **CAUTION:** There is a danger of a new battery exploding if it is incorrectly installed. Replace the battery only with the same or equivalent type recommended by the manufacturer. Discard used batteries according to the manufacturer's instructions.

 **CAUTION:** Before you begin any of the procedures in this section, follow the safety instructions located in the *Product Information Guide*.

Replace the battery — If you have to repeatedly reset time and date information after turning on the computer, or if an incorrect time or date displays during start-up, [replace the battery](#). If the battery still does not work properly, [contact Dell](#).

Drive Problems

 **CAUTION:** Before you begin any of the procedures in this section, follow the safety instructions located in the *Product Information Guide*.

Fill out the [Diagnostics Checklist](#) as you complete these checks.

Test the drive —

- 1 Insert another floppy disk, CD, or DVD to eliminate the possibility that the original one is defective.
- 1 Insert a bootable floppy disk and restart the computer.

Clean the drive or disk — See "[Cleaning Your Computer](#)."

Check the cable connections

[Check for software and hardware conflicts](#)

[Run the Dell Diagnostics](#)

CD and DVD drive problems

 **NOTE:** Because of different regions worldwide and different disc formats, not all DVD titles work in all DVD drives.

Adjust the Windows volume control —

- 1 Click the speaker icon in the lower-right corner of your screen.
- 1 Ensure that the volume is turned up by clicking the sidebar and dragging it up.
- 1 Ensure that the sound is not muted by clicking any boxes that are checked.

Check the speakers and subwoofer — See "[Sound and Speaker Problems](#)."

Problems writing to a CD/DVD-RW drive

Close other programs — The CD/DVD-RW drive must receive a steady stream of data when writing. If the stream is interrupted, an error occurs. Try closing all programs before you write to the CD/DVD-RW.

Turn off Standby mode in Windows before writing to a CD/DVD-RW disc — See "[Power Management](#)."

Hard drive problems

Running the Dell IDE Hard Drive Diagnostics —

The Dell IDE Hard Drive Diagnostics is a utility that tests the hard drive to troubleshoot or confirm a hard drive failure.

1. Turn on your computer (if your computer is already on, restart it).
2. When F2 = Setup appears in the upper-right corner of the screen, press <Ctrl><Alt><d>.
3. Follow the instructions on the screen.

Run Check Disk —

1. Click the **Start** button and click **My Computer**.
2. Right-click **Local Disk C:**.
3. Click **Properties**.
4. Click the **Tools** tab.
5. Under **Error-checking**, click **Check Now**.
6. Click **Scan for and attempt recovery of bad sectors**.
7. Click **Start**.

Keyboard Problems

 **CAUTION:** Before you begin any of the procedures in this section, follow the safety instructions located in the *Product Information Guide*.

Check the keyboard cable —

- 1 Ensure that the keyboard cable is firmly connected to the computer.
- 1 Shut down the computer, reconnect the keyboard cable as shown in the *Quick Reference Guide* for your computer, and then restart the computer.
- 1 Check the cable connector for bent or broken pins and for damaged or frayed cables. Straighten bent pins.
- 1 Remove keyboard extension cables and connect the keyboard directly to the computer.

Test the keyboard — Connect a properly working keyboard to the computer, and try using the keyboard. If the new keyboard works, the original keyboard is faulty.

[Run the Dell Diagnostics](#)

[Check for software and hardware conflicts](#)

Lockups and Software Problems

 **CAUTION:** Before you begin any of the procedures in this section, follow the safety instructions located in the *Product Information Guide*.

 **NOTE:** If you installed a unique image on your computer or if you had to reinstall your operating system, run the DSS utility. DSS is available on your [Drivers and Utilities CD](#) and at [support.dell.com](#).

 **NOTE:** You must use Microsoft® Windows® XP Service Pack 1 or later when you reinstall Windows XP.

The computer does not start up

[Check the Diagnostic Lights](#)

Ensure that the power cable is firmly connected to the computer and to the electrical outlet

The computer stops responding

 **NOTICE:** You might lose data if you are unable to perform an operating system shutdown.

Turn the computer off — If you are unable to get a response by pressing a key on your keyboard or moving your mouse, press and hold the power button for at least 8 to 10 seconds until the computer turns off. Then restart your computer.

A program stops responding

End the program —

1. Press <Ctrl><Shift><Esc> simultaneously.
2. Click **Applications**.
3. Click the program that is no longer responding.
4. Click **End Task**.

A program crashes repeatedly

 **NOTE:** Software usually includes installation instructions in its documentation or on a floppy disk or CD.

Check the software documentation — If necessary, uninstall and then reinstall the program.

A solid blue screen appears

Ensure that the original installed version of Windows XP is installed on your computer

Turn the computer off — If you are unable to get a response by pressing a key on your keyboard or moving your mouse, press and hold the power button for at least 8 to 10 seconds until the computer turns off. Then restart your computer.

Other software problems

Check the software documentation or contact the software manufacturer for troubleshooting information —

- 1 Ensure that the program is compatible with the operating system installed on your computer.
- 1 Ensure that your computer meets the minimum hardware requirements needed to run the software. See the software documentation for information.
- 1 Ensure that the program is installed and configured properly.
- 1 Verify that the device drivers do not conflict with the program.
- 1 If necessary, uninstall and then reinstall the program.

Back up your files immediately

Use a virus-scanning program to check the hard drive, floppy disks, or CDs

Save and close any open files or programs and shut down your computer through the Start menu

Run the Dell Diagnostics — If all tests run successfully, the error condition is related to a software problem.

Memory Problems

 **NOTE:** Your computer might emit a series of beeps (beep code) during start-up if the monitor cannot display errors or problems. This series of beeps identifies a problem. See "[Beep Codes](#)" for more information.

Fill out the [Diagnostics Checklist](#) as you complete these checks.

 **CAUTION:** Before you begin any of the procedures in this section, follow the safety instructions located in the *Product Information Guide*.

If you receive an insufficient memory message —

- 1 Save and close any open files and exit any open programs you are not using to see if that resolves the problem.
- 1 See the software documentation for minimum memory requirements. If necessary, [install additional memory](#).
- 1 [Reseat the memory modules](#) to ensure that your computer is successfully communicating with the memory.
- 1 Run the [Dell Diagnostics](#).

If you experience other memory problems —

- 1 [Reseat the memory modules](#) to ensure that your computer is successfully communicating with the memory.
- 1 Ensure that you are following the [memory installation guidelines](#).
- 1 Run the [Dell Diagnostics](#).

Mouse Problems

 **CAUTION:** Before you begin any of the procedures in this section, follow the safety instructions located in the *Product Information Guide*.

Check the mouse cable —

1. Check the cable connector for bent or broken pins and for damaged or frayed cables. Straighten bent pins.
2. Remove mouse extension cables, if used, and connect the mouse directly to the computer.
3. Shut down the computer, reconnect the mouse cable as shown in the *Quick Reference Guide* for your computer, and then restart the computer.

Restart the computer —

1. Simultaneously press <Ctrl><Esc> to display the **Start** menu.
2. Type u, press the keyboard arrow keys to highlight **Shut down** or **Turn Off**, and then press <Enter>.
3. After the computer turns off, reconnect the mouse cable as shown on the in the *Quick Reference Guide* for your computer.
4. Start the computer.

Test the mouse — Connect a properly working mouse to the computer, and try using the mouse. If the new mouse works, the original mouse is faulty.

Check the mouse settings —

1. Click the **Start** button, click **Control Panel**, and then click **Printers and Other Hardware**.
2. Click **Mouse**.
3. Try adjusting the settings.

If you are using a PS/2 mouse

1. [Enter system setup](#) and ensure that the **Mouse Port** option is set to **On**.
2. Exit system setup and restart the computer.

[Reinstall the mouse driver](#)

[Run the Dell Diagnostics](#)

[Check for software and hardware conflicts](#)

Network Problems

Fill out the [Diagnostics Checklist](#) as you complete these checks.

 **CAUTION:** Before you begin any of the procedures in this section, follow the safety instructions located in the *Product Information Guide*.

Check the network cable connector — Ensure that the network cable is firmly inserted into both the network connector on the back of the computer and the network jack.

Check the network lights on the front or back of the computer depending on system chassis type. — No connection speed light indicates that no network communication exists. Replace the network cable.

Restart the computer and log on to the network again

Check your network settings — Contact your network administrator or the person who set up your network to verify that your network settings are correct and that the network is functioning.

[Check for software and hardware conflicts](#)

Power Problems

Fill out the [Diagnostics Checklist](#) as you complete these checks.

 **CAUTION:** Before you begin any of the procedures in this section, follow the safety instructions located in the *Product Information Guide*.

If the power light is green and the computer is not responding — See "[Diagnostic Lights](#)."

If the power light is blinking green — The computer is in standby mode. Press a key on the keyboard or move the mouse to resume normal operation.

If the power light is off — The computer is either turned off or is not receiving power.

1. Reseat the power cable into both the power connector on the back of the computer and the electrical outlet.
1. If the computer is plugged into a power strip, ensure that the power strip is plugged into an electrical outlet and that the power strip is turned on. Also bypass power protection devices, power strips, and power extension cables to verify that the computer turns on properly.

- 1 Ensure that the electrical outlet is working by testing it with another device, such as a lamp.
- 1 Ensure that the main power cable and front panel cable are securely connected to the system board.

If the power light is amber and green or steady amber — A device might be malfunctioning or incorrectly installed.

- 1 [Remove and then reinstall the memory modules.](#)
- 1 Remove and then reinstall any cards.
- 1 Remove and then reinstall the graphics card, if applicable.

If the power light is blinking amber —

The computer is receiving electrical power, but an internal power problem might exist.

- 1 Ensure that the voltage selection switch is set to match the AC power at your location (if applicable).
- 1 Ensure that the processor power cable is securely connected to the system board.

Eliminate interference — Some possible causes of interference are:

- 1 Power, keyboard, and mouse extension cables
- 1 Too many devices on a power strip
- 1 Multiple power strips connected to the same electrical outlet

Printer Problems

Fill out the [Diagnostics Checklist](#) as you complete these checks.

 **CAUTION:** Before you begin any of the procedures in this section, follow the safety instructions located in the *Product Information Guide*.

 **NOTE:** If you need technical assistance for your printer, contact the printer's manufacturer.

Check the printer documentation — See the printer documentation for setup and troubleshooting information.

Ensure that the printer is turned on

Check the printer cable connections —

- 1 See the printer documentation for cable connection information.
- 1 Ensure that the printer cables are securely connected to the printer and the computer.

Test the electrical outlet — Ensure that the electrical outlet is working by testing it with another device, such as a lamp.

Verify that the printer is recognized by Windows —

1. Click the **Start** button, click **Control Panel**, and then click **Printers and Other Hardware**.
2. Click **View installed printers or fax printers**.

If the printer is listed, right-click the printer icon.

3. Click **Properties** and click the **Ports** tab. For a parallel printer, ensure that the **Print to the following port(s):** setting is **LPT1 (Printer Port)**. For a USB printer, ensure that the **Print to the following port(s):** setting is **USB**.

Reinstall the printer driver — See the printer documentation for instructions

Restoring Default Settings

To restore the computer's system settings to their default values —

1. Turn on or restart your computer.
2. When Press <F2> to Enter Setup appears in the upper-right corner of the screen, press <F2> immediately.

If you wait too long and the Microsoft® Windows® logo appears, continue to wait until you see the Windows desktop. Then shut down your computer through the **Start** menu and try again.

3. Under **System Management**, select the **Maintenance** option and follow the directions on the screen.

Serial or Parallel Device Problems

Fill out the [Diagnostics Checklist](#) as you complete these checks.

 **CAUTION:** Before you begin any of the procedures in this section, follow the safety instructions located in the *Product Information Guide*.

 **NOTE:** If you are having a problem with a printer, see "[Printer Problems](#)."

Check the option setting — See the device's documentation for the recommended settings. Then [enter system setup](#) and ensure that the **Serial Port #1** setting or the **LPT Port Mode** setting matches the recommended settings.

[Run the Dell Diagnostics](#)

Sound and Speaker Problems

Fill out the [Diagnostics Checklist](#) as you complete these checks.

 **CAUTION:** Before you begin any of the procedures in this section, follow the safety instructions located in the *Product Information Guide*.

No sound from speakers

 **NOTE:** The volume control in some MP3 players overrides the Windows volume setting. If you have been listening to MP3 songs, ensure that you did not turn the player volume down or off.

Check the speaker cable connections — Ensure that the speakers are connected as shown on the setup diagram supplied with the speakers. If you purchased an audio card, ensure that the speakers are connected to the card.

Ensure that the subwoofer and the speakers are turned on — See the setup diagram supplied with the speakers. If your speakers have volume controls, adjust the volume, bass, or treble to eliminate distortion.

Adjust the Windows volume control — Click or double-click the speaker icon in the lower-right corner of your screen. Ensure that the volume is turned up and that the sound is not muted.

Disconnect headphones from the headphone connector — Sound from the speakers is automatically disabled when headphones are connected to the computer's front-panel headphone connector.

Test the electrical outlet — Ensure that the electrical outlet is working by testing it with another device, such as a lamp.

Enable digital mode — Your speakers do not work if the CD drive is operating in analog mode.

1. Click the **Start** button, click **Control Panel**, and then click **Sounds, Speech, and Audio Devices**.
2. Click **Sounds and Audio Devices**.
3. Click the **Hardware** tab.
4. Double-click the name of your CD drive.
5. Click the **Properties** tab.
6. Check the **Enable digital CD audio for this CD-ROM device** box.

Eliminate possible interference — Turn off nearby fans, fluorescent lights, or halogen lamps to check for interference.

Run the speaker diagnostics

[Reinstall the audio driver](#)

Check the device option setting — [Enter system setup](#) and ensure that the **Audio Controller** option is set to **On**. Exit system setup and restart your computer.

[Enter system setup](#)

[Run the Dell Diagnostics](#)

[Check for software and hardware conflicts](#)

No sound from headphones

Check the headphone cable connection — Ensure that the headphone cable is securely inserted into the headphone connector.

Disable digital mode — Your headphones do not work if the CD drive is operating in digital mode.

1. Click the **Start** button, click **Control Panel**, and then click **Sounds, Speech, and Audio Devices**.
2. Click **Sounds and Audio Devices**.
3. Click the **Hardware** tab.
4. Double-click the name of your CD drive.
5. Click the **Properties** tab.
6. Uncheck the **Enable digital CD audio for this CD-ROM device** box.

Adjust the Windows volume control — Click or double-click the speaker icon in the lower-right corner of your screen. Ensure that the volume is turned up and that the sound is not muted.

Video and Monitor Problems

Fill out the [Diagnostics Checklist](#) as you complete these checks.

 **CAUTION:** Before you begin any of the procedures in this section, follow the safety instructions located in the *Product Information Guide*.

If the screen is blank

 **NOTE:** See the monitor documentation for troubleshooting procedures.

Check the monitor cable connection —

1. If you purchased a graphics card, ensure that the monitor is connected to the card.
1. Ensure that your monitor is properly connected (see the *Quick Reference Guide* that came with your computer).
1. If you are using a video extension cable and removing the cable solves the problem, the cable is defective.
1. Swap the computer and monitor power cables to determine if the power cable is defective.
1. Check the connector for bent or broken pins. (It is normal for monitor cable connectors to have missing pins.)

Check the monitor power light — If the power light is off, firmly press the button to ensure that the monitor is turned on. If the power light is lit or blinking, the monitor has power. If the power light is blinking, press a key on the keyboard or move the mouse.

Test the electrical outlet — Ensure that the electrical outlet is working by testing it with another device, such as a lamp.

Test the monitor — Connect a properly working monitor to the computer, and try using the monitor. If the new monitor works, the original monitor is faulty.

[Check the diagnostic lights](#)

Check the card setting — [Enter system setup](#) and ensure that **Primary Video** option is set correctly. Exit system setup and restart your computer.

Run the monitor self-test — Check the monitor documentation for more information.

If the screen is difficult to read

Check the monitor settings — See the monitor documentation for instructions on adjusting the contrast and brightness, demagnetizing (degaussing) the monitor, and running the monitor self-test.

Move the subwoofer away from the monitor — If your speaker system includes a subwoofer, ensure that the subwoofer is at least 60 cm (2 ft) away from the monitor.

Move the monitor away from external power sources — Fans, fluorescent lights, halogen lamps, and other electrical devices can cause the screen image to appear "shaky." Turn off nearby devices to check for interference.

Adjust the Windows display settings —

1. Click the **Start** button, click **Control Panel**, and then click **Appearance and Themes**.
2. Click **Display** and click the **Settings** tab.
3. Try different settings for **Screen resolution** and **Color quality**.

[Back to Contents Page](#)

[Back to Contents Page](#)

Dell™ OptiPlex™ 210L User's Guide



NOTE: A NOTE indicates important information that helps you make better use of your computer.



NOTICE: A NOTICE indicates either potential damage to hardware or loss of data and tells you how to avoid the problem.



CAUTION: A CAUTION indicates a potential for property damage, personal injury, or death.

For a complete list of abbreviations and acronyms, see the [Glossary](#).

If you purchased a Dell™ n Series computer, any references in this document to Microsoft® Windows® operating systems are not applicable.

Information in this document is subject to change without notice.
© 2005 Dell Inc. All rights reserved.

Reproduction in any manner whatsoever without the written permission of Dell Inc. is strictly forbidden.

Trademarks used in this text: *Dell*, the *DELL* logo, *OptiPlex*, *Inspiron*, *Dimension*, *Latitude*, *Dell Precision*, *DellNet*, *TravelLite*, *Dell OpenManage*, *PowerVault*, *Axim*, *PowerEdge*, *PowerConnect*, and *PowerApp* are trademarks of Dell Inc.; *Intel*, *Pentium*, and *Celeron* are registered trademarks of Intel Corporation; *Microsoft*, *MS-DOS*, and *Windows* are registered trademarks of Microsoft Corporation; *IBM* is a registered trademark of International Business Machines Corporation; *Bluetooth* is a trademark owned by Bluetooth SIG, Inc. and is used by Dell Inc. under license. *ENERGY STAR* is a registered trademark of the U.S. Environmental Protection Agency. As an ENERGY STAR partner, Dell Inc. has determined that this product meets the ENERGY STAR guidelines for energy efficiency.

Other trademarks and trade names may be used in this document to refer to either the entities claiming the marks and names or their products. Dell Inc. disclaims any proprietary interest in trademarks and trade names other than its own.

Models: DCTR and DCNE

July 2006 P/N GD045 Rev. A02

[Back to Contents Page](#)

Troubleshooting Tools and Utilities

Dell™ OptiPlex™ 210L User's Guide

- [Dell Diagnostics](#)
 - [System Lights](#)
 - [Diagnostic Lights](#)
 - [Beep Codes](#)
 - [Error Messages](#)
 - [Resolving Software and Hardware Incompatibilities](#)
-

Dell Diagnostics

 **CAUTION:** Before you begin any of the procedures in this section, follow the safety instructions located in the *Product Information Guide*.

When to Use the Dell Diagnostics

If you experience a problem with your computer, perform the checks in this section and run the Dell Diagnostics before you [contact Dell](#) for technical assistance.

It is recommended that you print these procedures before you begin.

 **NOTICE:** The Dell Diagnostics works only on Dell™ computers.

[Enter system setup](#), review your computer's configuration information, and ensure that the device you want to test displays in system setup and is active.

Start the Dell Diagnostics from either your [hard drive](#) or from the [Drivers and Utilities CD](#) (an optional CD also known as the ResourceCD).

Starting the Dell Diagnostics From Your Hard Drive

1. Turn on (or restart) your computer.
2. When the DELL™ logo appears, press <F12> immediately.

 **NOTE:** If you see a message stating that no diagnostics utility partition has been found, run the Dell Diagnostics from your *Drivers and Utilities CD* (optional).

If you wait too long and the operating system logo appears, continue to wait until you see the Microsoft® Windows® desktop. Then shut down your computer and try again.

3. When the boot device list appears, highlight **Boot to Utility Partition** and press <Enter>.
4. When the Dell Diagnostics **Main Menu** appears, [select the test you want to run](#).

Starting the Dell Diagnostics From the Drivers and Utilities CD (Optional)

1. Insert the [Drivers and Utilities CD](#) (optional).
2. Shut down and restart the computer.

When the DELL logo appears, press <F12> immediately.

If you wait too long and the Windows logo appears, continue to wait until you see the Windows desktop. Then shut down your computer and try again.

 **NOTE:** The next steps change the boot sequence for one time only. On the next start-up, the computer boots according to the devices specified in system setup.

3. When the boot device list appears, highlight **IDE CD-ROM Device** and press <Enter>.
4. Select the **IDE CD-ROM Device** option from the CD boot menu.
5. Select the **Boot from CD-ROM** option from the menu that appears.

6. Type 1 to start the *Drivers and Utilities* CD menu.
7. Type 2 to start the Dell Diagnostics.
8. Select **Run the 32 Bit Dell Diagnostics** from the numbered list. If multiple versions are listed, select the version appropriate for your computer.
9. When the Dell Diagnostics **Main Menu** appears, [select the test you want to run](#).

Dell Diagnostics Main Menu

1. After the Dell Diagnostics loads and the **Main Menu** screen appears, click the button for the option you want.

Option	Function
Express Test	Performs a quick test of devices. This test typically takes 10 to 20 minutes and requires no interaction on your part. Run Express Test first to increase the possibility of tracing the problem quickly.
Extended Test	Performs a thorough check of devices. This test typically takes an hour or more and requires you to answer questions periodically.
Custom Test	Tests a specific device. You can customize the tests you want to run.
Symptom Tree	Lists the most common symptoms encountered and allows you to select a test based on the symptom of the problem you are having.

2. If a problem is encountered during a test, a message appears with an error code and a description of the problem. Write down the error code and problem description and follow the instructions on the screen.

If you cannot resolve the error condition, [contact Dell](#).

 **NOTE:** The Service Tag for your computer is located at the top of each test screen. If you contact Dell, technical support will ask for your Service Tag. Your computer's Service Tag is listed in the **System Info** option in [system setup](#).

3. If you run a test from the **Custom Test** or **Symptom Tree** option, click the applicable tab described in the following table for more information.

Tab	Function
Results	Displays the results of the test and any error conditions encountered.
Errors	Displays error conditions encountered, error codes, and the problem description.
Help	Describes the test and may indicate requirements for running the test.
Configuration	Displays your hardware configuration for the selected device. The Dell Diagnostics obtains configuration information for all devices from system setup, memory, and various internal tests, and it displays the information in the device list in the left pane of the screen. The device list may not display the names of all the components installed on your computer or all devices attached to your computer.
Parameters	Allows you to customize the test by changing the test settings.

4. When the tests are completed, if you are running the Dell Diagnostics from the *Drivers and Utilities CD*, remove the CD.
5. Close the test screen to return to the **Main Menu** screen. To exit the Dell Diagnostics and restart the computer, close the **Main Menu** screen.

System Lights

Your power button light and hard-drive light may indicate a computer problem.

Power Light	Problem Description	Suggested Resolution
Solid green	Power is on, and the computer is operating normally. On the desktop computer, a solid green light indicates a network connection.	No corrective action is required.
Blinking green	The computer is in a power-saving mode (Microsoft® Windows® XP).	Press the power button, move the mouse, or press a key on the keyboard to wake the computer.
Blinks green several times and then turns off	A configuration error exists.	Check the diagnostic lights to see if the specific problem is identified.
Solid yellow	The Dell Diagnostics is running a test, or a device on the system board may be faulty or incorrectly installed.	If the Dell Diagnostics is running, allow the testing to complete.

		If the computer does not boot, contact Dell for technical assistance.
Blinking yellow	A power supply or system board failure has occurred.	See " Power Problems ."
Solid green and a beep code during POST	A problem was detected while the BIOS was executing.	See " Beep Codes " for instructions on diagnosing the beep code. Also, check the diagnostic lights to see if the specific problem is identified.
Solid green power light and no beep code and no video during POST	The monitor or the graphics card may be faulty or incorrectly installed.	Check the diagnostic lights to see if the specific problem is identified. See " Video and Monitor Problems ."
Solid green power light and no beep code but the computer locks up during POST	An integrated system board device may be faulty.	Check the diagnostic lights to see if the specific problem is identified. If the problem is not identified, contact Dell for technical assistance.



Diagnostic Lights

⚠ CAUTION: Before you begin any of the procedures in this section, follow the safety instructions located in the *Product Information Guide*.

To help you troubleshoot a problem, your computer has four lights labeled "1," "2," "3," and "4" on the front or back panel. The lights can be off or green. When the computer starts normally, the patterns or codes on the lights change as the boot process completes. When the computer starts normally, the patterns or codes on the lights change as the boot process completes. If the POST portion of system boot completes successfully, all four lights display solid green. If the computer malfunctions during the POST process, the pattern displayed on the LEDs may help identify where in the process the computer halted.

📌 NOTE: The orientation of the diagnostic lights may vary depending on the system type. The diagnostic lights can appear either vertical or horizontal.

Light Pattern	Problem Description	Suggested Resolution
①②③④	The computer is in a normal "off" condition, or a possible pre-BIOS failure has occurred. The diagnostic lights are not lit after the computer successfully boots to the operating system.	Plug the computer into a working electrical outlet and press the power button.
①②③④	A possible BIOS failure has occurred; the computer is in the recovery mode.	Run the BIOS Recovery utility, wait for recovery completion, and then restart the computer.
①②③④	A possible processor failure has occurred.	Reinstall the processor and restart the computer.
①②③④	Memory modules are detected, but a memory failure has occurred.	<ul style="list-style-type: none"> 1 If you have one memory module installed, reinstall it and restart the computer. (see "Memory" for instructions on how to remove and install memory modules.) 1 If you have two or more memory modules installed, remove the modules, reinstall one module, and then restart the computer. If the computer starts normally, reinstall an additional module. Continue until you have identified a faulty module or reinstalled all modules without error. 1 If available, install properly working memory of the same type into your computer. 1 If the problem persists, contact Dell.
①②③④	A possible graphics card failure has occurred.	<ul style="list-style-type: none"> 1 If the computer has a graphics card, remove the card, reinstall it, and then restart the computer. 1 If the problem still exists, install a graphics card that you know works and restart the computer. 1 If the problem persists or the computer has integrated graphics, contact Dell.
①②③④	A possible floppy or hard drive failure has occurred.	Reseat all power and data cables and restart the computer.
①②③④	A possible USB failure has occurred.	Reinstall all USB devices, check cable connections, and then restart the computer.
①②③④	No memory modules are detected.	<ul style="list-style-type: none"> 1 If you have one memory module installed, reinstall it and restart the computer. (see "Memory" for instructions on how to remove and install memory modules.) 1 If you have two or more memory modules installed, remove the modules, reinstall one module, and then restart the computer. If the computer starts normally, reinstall an additional module. Continue until you have identified a faulty module or reinstalled all modules without error. 1 If available, install properly working memory of the same type into your computer. 1 If the problem persists, contact Dell.
①②③④	Memory modules are detected, but a memory configuration or compatibility error exists.	<ul style="list-style-type: none"> 1 Ensure that no special memory module/memory connector placement requirements exist. 1 Verify that the memory modules that you are installing are compatible with your computer. 1 If the problem persists, contact Dell.

	<p>A failure has occurred.</p> <p>This pattern also displays when you enter system setup and may not indicate a problem.</p>	<ul style="list-style-type: none"> 1 Ensure that the cables are properly connected to the system board from the hard drive, CD drive, and DVD drive. 1 Check the computer message that appears on your monitor screen. 1 If the problem persists, contact Dell.
	<p>After POST is complete, all four diagnostic lights turn green briefly before turning off to indicate normal operating condition.</p>	<p>None.</p>

Beep Codes

Your computer might emit a series of beeps during start-up if the monitor cannot display errors or problems. This series of beeps, called a beep code, identifies a problem. One possible beep code (code 1-3-1) consists of one beep, a burst of three beeps, and then one beep. This beep code tells you that the computer encountered a memory problem.

If your computer beeps during start-up:

1. Write down the beep code on the Diagnostics Checklist.
2. Run the [Dell Diagnostics](#) to identify a more serious cause.
3. [Contact Dell](#) for technical assistance.

Code	Cause
1-1-2	Microprocessor register failure
1-1-3	NVRAM read/write failure
1-1-4	ROM BIOS checksum failure
1-2-1	Programmable interval timer failure
1-2-2	DMA initialization failure
1-2-3	DMA page register read/write failure
1-3	Video Memory test failure
1-3-1 through 2-4-4	Memory not being properly identified or used
3-1-1	Slave DMA register failure
3-1-2	Master DMA register failure
3-1-3	Master interrupt mask register failure
3-1-4	Slave interrupt mask register failure
3-2-2	Interrupt vector loading failure
3-2-4	Keyboard Controller test failure
3-3-1	NVRAM power loss
3-3-2	Invalid NVRAM configuration
3-3-4	Video Memory test failure
3-4-1	Screen initialization failure
3-4-2	Screen retrace failure
3-4-3	Search for video ROM failure
4-2-1	No timer tick
4-2-2	Shutdown failure
4-2-3	Gate A20 failure
4-2-4	Unexpected interrupt in protected mode
4-3-1	Memory failure above address 0FFFFh
4-3-3	Timer-chip counter 2 failure
4-3-4	Time-of-day clock stopped
4-4-1	Serial or parallel port test failure
4-4-2	Failure to decompress code to shadowed memory
4-4-3	Math-coprocessor test failure
4-4-4	Cache test failure

Error Messages

Fill out the [Diagnostics Checklist](#) as you complete these checks.

 **CAUTION:** Before you begin any of the procedures in this section, follow the safety instructions located in the *Product Information Guide*.

If the message is not listed, see the documentation for the operating system or the program that was running when the message appeared.

<p>A filename cannot contain any of the following characters: \ / : * ? " < > — Do not use these characters in filenames.</p>
<p>A required .DLL file was not found — The program that you are trying to open is missing an essential file. To remove and then reinstall the program:</p> <ol style="list-style-type: none">1. Click the Start button, click Control Panel, and then click Add or Remove Programs.2. Select the program you want to remove.3. Click the Change or Remove Program icon.4. See the program documentation for installation instructions.
<p>Alert! Previous attempts at booting this system have failed at checkpoint [nnnn]. For help in resolving this problem, please note this checkpoint and contact Dell Technical Support — Contact Dell and report the checkpoint code (nnnn) to the support technician.</p>
<p>Attachment failed to respond — See "Drive Problems."</p>
<p>Bad command or file name — Ensure that you spelled the command correctly, put spaces in the proper place, and used the correct pathname.</p>
<p>Bad error-correction code (ECC) on disk read — See "Drive Problems."</p>
<p>Controller has failed — See "Drive Problems."</p>
<p>Data error — See "Drive Problems."</p>
<p>Decreasing available memory —</p> <p>See "Lockups and Software Problems."</p>
<p>Diskette drive 0 seek failure — See "Drive Problems."</p>
<p>Diskette read failure —</p> <p>See "Drive Problems."</p>
<p>Diskette subsystem reset failed — Run the Dell Diagnostics.</p>
<p>Diskette write protected — Slide the write-protect notch on the floppy disk to the open position.</p>
<p>Drive not ready — Put a floppy disk in the drive.</p>
<p>Gate A20 failure —</p> <p>See "Lockups and Software Problems."</p>
<p>Hard-disk configuration error —</p> <p>Hard-disk controller failure —</p> <p>Hard-disk drive failure —</p> <p>Hard-disk drive failure —</p> <p>See "Drive Problems."</p>

Insert bootable media — Insert a bootable floppy disk or CD.

Invalid configuration information - please run SETUP program — [Enter system setup](#) and correct the computer configuration information.

Keyboard failure — See "[Keyboard Problems](#)."

Memory address line failure at address, read value expecting value — See "[Lockups and Software Problems](#)."

Memory allocation error —

1. Turn off the computer, wait 30 seconds, and then restart the computer.
2. Try to run the program again.
3. If the error message appears again, see the software documentation for additional troubleshooting suggestions.

Memory data line failure at address, read value expecting value —

Memory double word logic failure at address, read value expecting value —

Memory odd/even logic failure at address, read value expecting value —

Memory write/read failure at address, read value expecting value —

Memory size in CMOS invalid —

See "[Lockups and Software Problems](#)."

No boot device available —

1. If the floppy drive is your boot device, ensure that a bootable floppy disk is in the drive.
1. If the hard drive is your boot device, ensure that the cables are connected and that the drive is installed properly and partitioned as a boot device.
1. [Enter system setup](#) and ensure that the boot sequence information is correct.

No boot sector on hard-disk drive — [Enter system setup](#) and ensure that the computer configuration information for the hard drive is correct.

No timer tick interrupt — Run the [Dell Diagnostics](#).

Non-system disk or disk error — Replace the floppy disk with one that has a bootable operating system or remove the floppy disk from drive A and restart the computer.

Not a boot diskette — Insert a bootable floppy disk and restart your computer.

Not enough memory or resources. Close some programs and try again — Close all windows and open the program that you want to use. In some cases, you might have to restart your computer to restore computer resources. If so, run the program that you want to use first.

Operating system not found — [Contact Dell](#).

Plug and Play Configuration Error —

1. Turn your computer off, unplug it from the electrical outlet, and then remove all but one of the cards.
2. Plug in your computer and reboot it.
3. If the message reappears, the installed card might be malfunctioning. If the message does not reappear, turn off the computer and reinsert one of the other cards.
4. Repeat this process until you identify which card is malfunctioning.

Read fault —

Requested sector not found —

Reset failed —

See "[Drive Problems](#)."

Sector not found —

- 1 Run the Windows error-checking utility to check the file structure on the floppy disk or hard drive. See Windows Help for instructions.
- 1 If a large number of sectors are defective, back up the data (if possible), and then reformat the floppy disk or hard drive.

Seek error — See "[Drive Problems](#)."

Shutdown failure — Run the [Dell Diagnostics](#).

Time-of-day clock stopped —

Time-of-day not set-please run the System Setup program —

[Enter system setup](#) and correct the date or time. If the problem persists, [replace the battery](#).

Timer chip counter 2 failed — Run the [Dell Diagnostics](#).

Unexpected interrupt in protected mode — Run the [Dell Diagnostics](#).

WARNING: Dell's Disk Monitoring System has detected that drive [0/1] on the [primary/secondary] EIDE controller is operating outside of normal specifications. **It is advisable to immediately back up your data and replace your hard drive by calling your support desk or Dell** —

If no replacement drive is immediately available and the drive is not the only bootable drive, [enter system setup](#) and change the appropriate drive setting to **None**. Then remove the drive from the computer.

Write fault —

Write fault on selected drive —

See "[Drive Problems](#)."

<drive letter>:\ is not accessible. The device is not ready — The selected drive cannot read its medium. Depending on its medium type, insert a floppy, CD, or Zip disk into the drive and try again.

Resolving Software and Hardware Incompatibilities

If a device is either not detected during the operating system setup or is detected but incorrectly configured, you can use Device Manager or the Hardware Troubleshooter to resolve the incompatibility.

Microsoft® Windows® XP

To resolve incompatibilities using Device Manager:

1. Click the **Start** button and click **Control Panel**.
2. Click **Performance and Maintenance** and click **System**.
3. Click the **Hardware** tab and click **Device Manager**.

4. In the **Device Manager** list, check for devices that are incorrectly configured.

Incorrectly configured devices are indicated by a yellow exclamation point (!) or a red x if the device has been disabled.

5. Double-click any device marked with an exclamation point to display the **Properties** window.

The **Device** status area in the **Properties** window reports the devices that need to be re-configured.

6. Reconfigure the devices or remove the devices from the **Device Manager**. See the documentation that came with the device for information on configuring the device.

To resolve incompatibilities using the Windows XP Hardware Troubleshooter:

1. Click the **Start** button and click **Help and Support**.
2. Type `hardware troubleshooter` in the **Search** field and click the arrow to start the search.
3. Click **Hardware Troubleshooter** in the **Search Results** list.
4. In the **Hardware Troubleshooter** list, click **I need to resolve a hardware conflict on my computer**, and click **Next**.

[Back to Contents Page](#)

[Back to Contents Page](#)

Warranty

Dell™ OptiPlex™ 210L User's Guide

Dell Inc. ("Dell") manufactures its hardware products from parts and components that are new or equivalent to new in accordance with industry-standard practices. For information about the Dell warranty for your computer, see the *Product Information Guide* or separate paper warranty document that shipped with your computer.

[Back to Contents Page](#)

Microsoft® Windows® XP Features

Dell™ OptiPlex™ 210L User's Guide

- [Transferring Information to a New Computer](#)
 - [User Accounts and Fast User Switching](#)
 - [Setting Up a Home and Office Network](#)
-

Transferring Information to a New Computer

The Microsoft Windows XP operating system provides a Files and Settings Transfer wizard to move data from the source computer to the new computer. You can move data such as:

- 1 E-mails
- 1 Toolbar settings
- 1 Window sizes
- 1 Internet bookmarks

You can transfer the data to the new computer over a network or serial connection, or you can store it on a removable medium, such as a writable CD or floppy disk.

To prepare the new computer for the file transfer:

1. Click the **Start** button, point to **All Programs**→ **Accessories**→ **System Tools**, and then click **Files and Settings Transfer Wizard**.
2. When the **Files and Settings Transfer Wizard** welcome screen appears, click **Next**.
3. On the **Which computer is this?** screen, click **New Computer** and click **Next**.
4. On the **Do you have a Windows XP CD?** screen, click **I will use the wizard from the Windows XP CD** and click **Next**.
5. When the **Now go to your old computer** screen appears, go to your old or source computer. *Do not* click **Next** at this time.

To copy data from the old computer:

1. On the old computer, insert the Windows XP *Operating System* CD.
2. On the **Welcome to Microsoft Windows XP** screen, click **Perform additional tasks**.
3. Under **What do you want to do?**, click **Transfer files and settings**.
4. On the **Files and Settings Transfer Wizard** welcome screen, click **Next**.
5. On the **Which computer is this?** screen, click **Old Computer** and click **Next**.
6. On the **Select a transfer method** screen, click the transfer method you prefer.
7. On the **What do you want to transfer?** screen, select the items you want to transfer and click **Next**.
After the information has been copied, the **Completing the Collection Phase** screen appears.
8. Click **Finish**.

To transfer data to the new computer:

1. On the **Now go to your old computer** screen on the new computer, click **Next**.
 2. On the **Where are the files and settings?** screen, select the method you chose for transferring your settings and files and click **Next**.
The wizard reads the collected files and settings and applies them to your new computer.
When all of the settings and files have been applied, the **Finished** screen appears.
 3. Click **Finished** and restart the new computer.
-

User Accounts and Fast User Switching

Adding User Accounts

After the Microsoft Windows XP operating system is installed, the administrator or a user with administrator rights can create additional user accounts.

1. Click the **Start** button and click **Control Panel**.
2. In the **Control Panel** window, click **User Accounts**.
3. Under **Pick a task**, click **Create a new account**.
4. Under **Name the new account**, type the name of the new user and click **Next**.
5. Under **Pick an account type**, click one of the following options:
 - 1 **Computer administrator** — You can change all computer settings.
 - 1 **Limited** — You can change only your own personal settings, such as your password. You cannot install programs or use the Internet.

 **NOTE:** Additional options may be available, depending on whether you are using Windows XP Home Edition or Windows XP Professional. Also, options available in Windows XP Professional vary depending on whether your computer is connected to a domain.

6. Click **Create Account**.

Fast User Switching

 **NOTE:** Fast User Switching is unavailable if your computer is running Windows XP Professional and is a member of a computer domain, or if your computer has less than 128 MB of memory.

Fast User Switching allows multiple users to access one computer without requiring the previous user to log off.

1. Click the **Start** button and click **Log Off**.
2. In the **Log Off Windows** window, click **Switch User**.

When you use Fast User Switching, programs that previous users were using remain running in the background, which might decrease your computer's response time. Also, multimedia programs, such as games and DVD software, might not work with Fast User Switching. For more information, see the Windows Help and Support Center.

Setting Up a Home and Office Network

Connecting to a Network Adapter

Before you connect your computer to a network, the computer must have a network adapter installed and a network cable connected to it.

To connect a network cable:

 **NOTE:** Insert the cable until it clicks into place, and then gently pull it to ensure that it is secure.

1. Connect the network cable to the network adapter connector on the back of your computer.

 **NOTE:** Do not use a network cable with a telephone wall jack.

2. Connect the other end of the network cable to a network connection device, such as a network wall jack.

Network Setup Wizard

The Microsoft Windows XP operating system provides a Network Setup Wizard to guide you through the process of sharing files, printers, or an Internet connection between computers in a home or small office.

1. Click the **Start** button, point to **All Programs**→ **Accessories**→ **Communications**, and then click **Network Setup Wizard**.
2. On the welcome screen, click **Next**.
3. Click **Checklist for creating a network**.

 **NOTE:** Selecting the connection method **This computer connects directly to the Internet** enables the integrated firewall provided with Windows XP SP1.

4. Complete the checklist and required preparations.
 5. Return to the Network Setup Wizard and follow the instructions on the screen.
-

[Back to Contents Page](#)